

ESSENTIALS

2020 | 2021

SATTLER

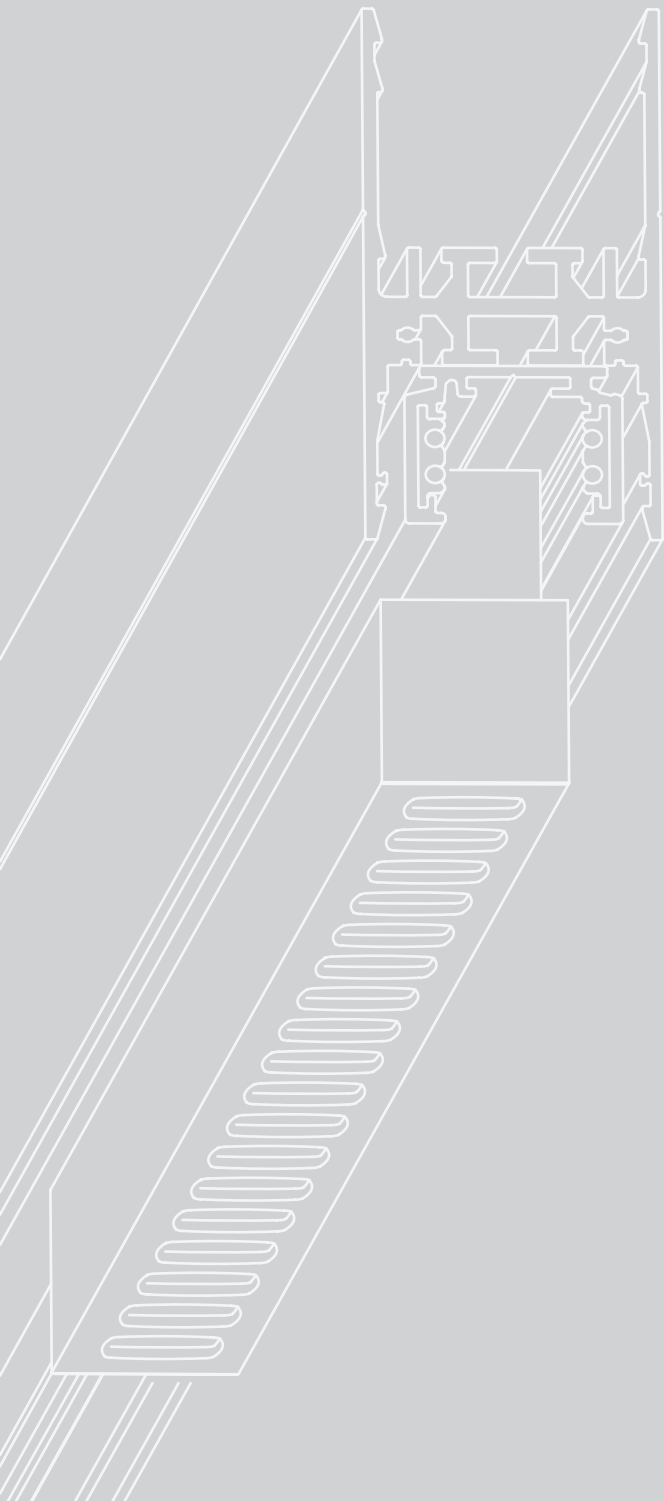

Das neue ESSENTIALS - Leuchtenprogramm von SATTLER definiert sich über eine Symbiose hochwertiger Verarbeitung, ansprechender Haptik und Funktionalität. Die in ihren Grundzügen eher technischen Leuchten wurden mit einer gehörigen Portion Sattler-DNA versehen und überzeugen nun durch ein Höchstmaß an lichttechnischen Variationsmöglichkeiten und gleichzeitig ansprechender Optik.

Durch die Kombinationsmöglichkeit vieler der neuen ESSENTIALS-Produkte mit Leuchten aus unserem bestehenden Produktportfolio und der Verwendung gleicher Oberflächen über das komplette SATTLER Produktprogramm hinweg entsteht ein breites Spektrum an kreativem, planerischen Freiraum unter Berücksichtigung von wirtschaftlichen Aspekten.

ESSENTIALS

The new ESSENTIALS luminaire series by SATTLER is defined by a symbiosis of high-quality workmanship, appealing haptics and functionality. The main features of the rather technical luminaires were provided with a good dose of Sattler DNA, thus providing a maximum of lighting options and at the same time appealing optics.

By combining many of the new ESSENTIALS products with luminaires from our existing product portfolio and by using the same surfaces across the entire SATTLER product range, a broad spectrum of creative planning freedom is possible while also taking economic aspects into account.



Sattler family
Sven | Ulrich | Petra | Tim

Seit der Unternehmensgründung in den späten 50er Jahren hat sich SATTLER zu einem international tätigen Unternehmen entwickelt. Über drei Generationen hinweg, vom Elektroinstallationsbetrieb mit klassischem Einzelhandel hin zu einem führenden Leuchtenhersteller, wurde sehr viel bewegt. Heute blickt SATTLER auf mehr als 30 Jahre Erfahrung in der Beleuchtungsbranche zurück und bietet dem Markt ein innovatives Portfolio an vielfach ausgezeichneten Designleuchten.

Since the company was founded in the late fifties, SATTLER has evolved into an international enterprise. Three generations have developed the company from an electrical installation and retail business to a leading lighting manufacturer.

As a result, SATTLER is now looking back on more than 30 years of experience in the lighting industry and is proud of its innovative portfolio of design luminaires that hold prestigious awards.



SATTTLER



Quality & Detail

QUALITY & DETAIL

Da die Charakteristik einer Leuchte stark durch die verwendeten Werkstoffe beeinflusst wird, weisen wir bei SATTLER der Auswahl der Werkstoffe einen hohen Stellenwert zu und verwenden nur qualitativ hochwertige Rohmaterialien. Zudem setzen wir auf ausgesuchte Veredelungsprozesse, welche unseren Leuchten eine besondere Optik und Haptik verleihen.

The characteristics of a luminaire are strongly influenced by the materials used. At SATTLER, we therefore assign top priority to the material selection and only make use of high-quality raw materials. We also place great emphasis on select finishing processes, thus lending a special look and feel to our luminaires.

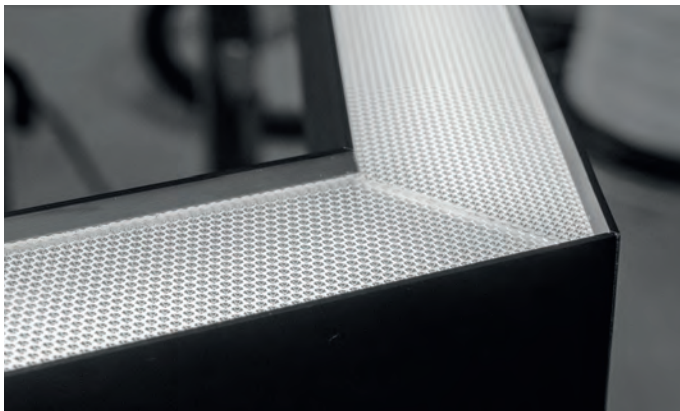

ESSENTIALS

SATTLER ESSENTIALS	3
---------------------------	---

PALADIO - A MODULAR SYSTEM	10
-----------------------------------	----

PALADIO - PRISM 35 54	16
PALADIO - LENS 35 54	22
PALADIO - TRACK 35	30
PALADIO - CONNECT 35 54	40
PALADIO DOWNLIGHT	48
PALADIO WALL	50

COVE LIGHTING	52
----------------------	----

DOWNLIGHTS SPOTS	54
---------------------------	----

EVOLUTION SPOT	56
EVOLUTION CEILING	58
BE 1	60
BE 2	62
BE 3	64
BE 3 HIGH OUTPUT	66

ROTOLO	70
---------------	----

DUETTO direct HIGH OUTPUT	74
DUETTO direct/indirect HIGH OUTPUT	76

LA BELLA	78
-----------------	----

PALADIO

A MODULAR SYSTEM

Das PALADIO Leuchtensystem ermöglicht durch sein modulares Konzept größtmöglichen Planungsspielraum bei der Konzeption raumübergreifender Beleuchtungslösungen. Das durchgängig minimalistische Design und die Kombinationsmöglichkeit unterschiedlichster Leuchtenarten gestattet vielfältige Lichtlösungen. Ob als PALADIO Einzel- oder Systemleuchte, mit Prismen oder Linsenreflektoren, Sie haben die Wahl. Darüber hinaus bietet die Variante PALADIO TRACK über eine Stromschiene die Möglichkeit, Lichtelemente und ausgesuchte Leuchten aus dem SATTLER Portfolio flexibel zu positionieren. Verschiedenste Einbau-, Aufbau-, und Pendelmontagevarianten ermöglichen auf unterschiedlichste bauseitige Gegebenheiten einzugehen.

Thanks to its modular concept, the PALADIO luminaire system enables the greatest possible planning freedom when designing room-spanning lighting solutions. The consistently minimalist design and combination options for many different luminaire types permit diverse lighting solutions.

Choose between the PALADIO single or system luminaire, with prisms or lens reflectors. The PALADIO TRACK version with a power track also makes it possible to flexibly position light elements and selected luminaires from the SATTLER range. Different installation, like built-in, surface mounted or pendant versions enable a wide range of on-site conditions to be addressed.

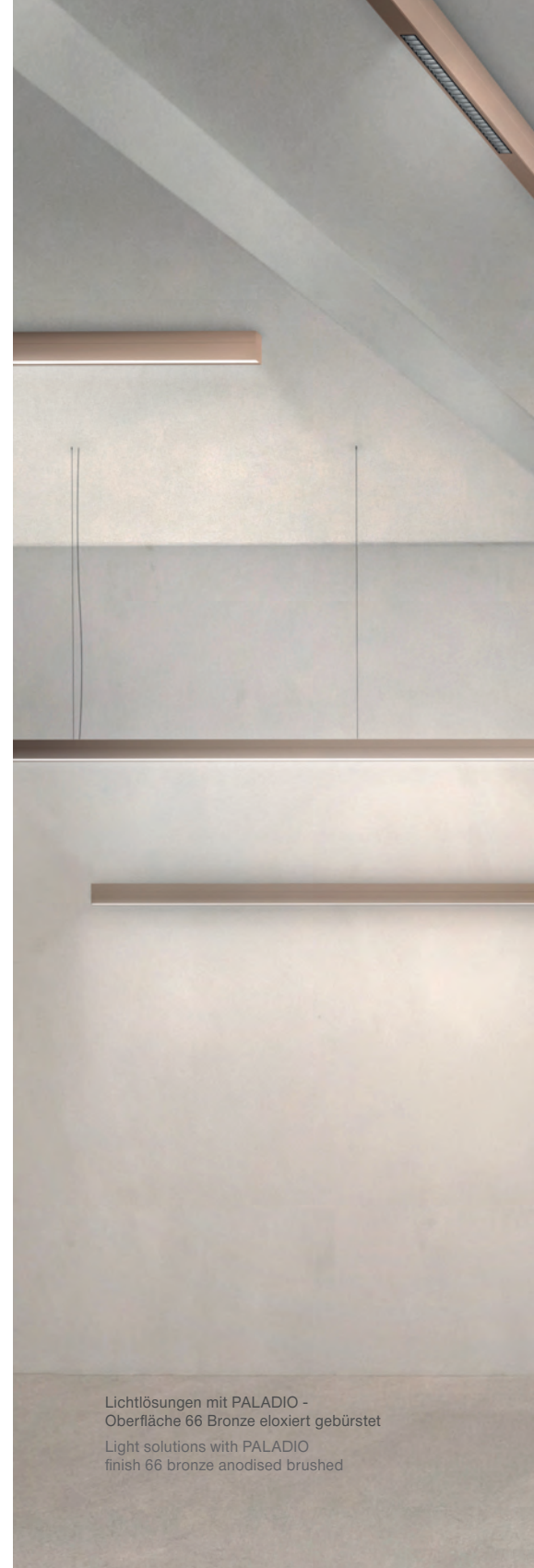

Lichtlösungen mit PALADIO -
Oberfläche 66 Bronze eloxiert gebürstet
Light solutions with PALADIO
finish 66 bronze anodised brushed



65 Champagner-Gold
champagne gold



66 Bronze
bronze

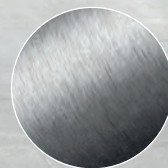

60 Silber
silver

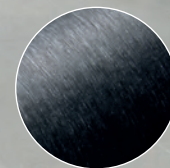

62 Schwarz
black

PALADIO

A MODULAR SYSTEM





PALADIO LENS 54 | SINGLE
Pendelleuchte | pendant
2 x 2810 mm | direct/indirect
Art. Nr. 2073.

PALADIO TRACK 35 | System
Deckenanbau | direct ceiling mounted

PALADIO CONNECT | T-connector
Art. Nr. 2243.

6 x AVVENI SPOT Art.Nr. 1805.
4 x Light Element Reflector
Art. Nr. 2012.

PALADIO

A MODULAR SYSTEM

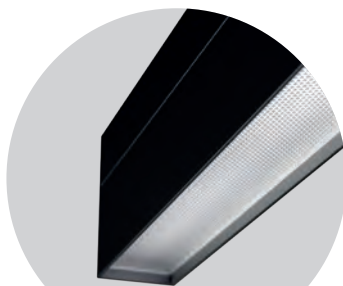

PALADIO 35

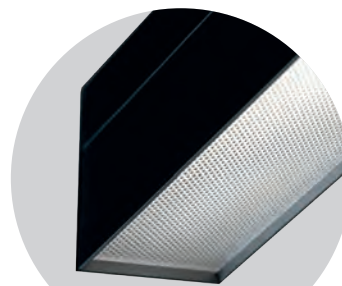

PALADIO 54

MOUNTING VERSIONS

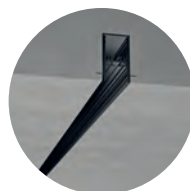
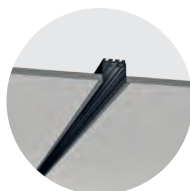

FINISHES

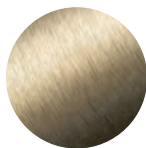

CHAMPAGNE GOLD

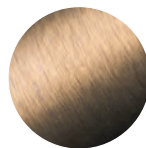

BRONZE

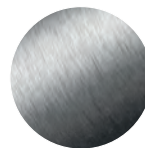

SILVER

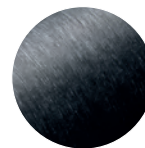

BLACK

TYPE

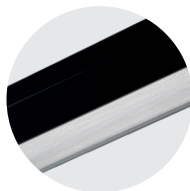

PRISM



LENS



TRACK



PALADIO CONNECT



90° CONNECTOR



120° CONNECTOR



T-CONNECTOR



CROSS CONNECTOR



INDIVIDUAL

LIGHT ELEMENTS

FOR PALADIO TRACK 35



FINO SPOT



EVOLUTION SPOT



AVVENI SPOT



LINEAR ELEMENTS
MICROPRISM /
OPAL / LENS



PALITO



FINO PENDANT



AVVENI PENDANT

PALADIO

A MODULAR SYSTEM

PALADIO PRISM

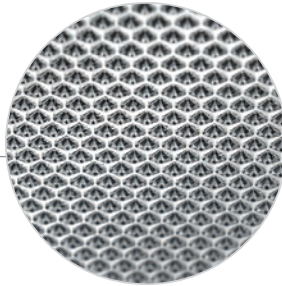

Der mikroprismatische Diffusor der PALADIO Serie bietet eine normgerechte Entblendung bei gleichzeitig hohem Wirkungsgrad. Der Diffusor sorgt durch den mehrschichtigen Aufbau für Blendfreiheit und ein homogenes Lichtbild bei gleichzeitig exakter Lichtverteilung.

Durch die prismatische Oberflächenstruktur wird das Licht in einem genau definierten Winkel von der Leuchte abgestrahlt und verteilt, dadurch werden unerwünschte Blend- und Spiegelungen verhindert. Die qualitativ hochwertige Optik garantiert eine Lichtdurchlässigkeit von 72% und lässt die PALADIO der Norm EN 12464-1 entsprechen. Um die nötige Flexibilität zu gewährleisten sind die Diffusoren mit einem 65° symmetrischen oder aber einem 15° asymmetrischen Diffusor erhältlich.

The micro prismatic diffuser of the PALADIO series offers glare control in compliance with standards and high efficiency at the same time. Thanks to its multilayer structure, the diffuser ensures a glare-free and homogeneous light pattern with precise light distribution.

Due to the prismatic surface structure, the light is emitted and distributed by the luminaire at a precisely defined angle, which prevents unwanted glare and reflections. The high-quality look warrants translucence of 72% and brings the PALADIO in compliance with standard EN 124641. The necessary flexibility is ensured by a 65° symmetrical or 15° asymmetrical diffuser.

DIRECT LIGHT OUTPUT

CRI >90

L80 | B10 | 72.000h

Effizienz /

Efficiency up to 72%

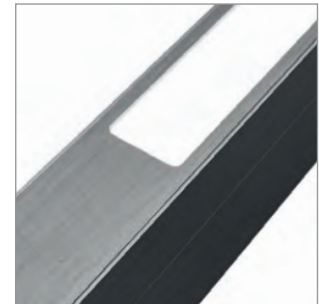

INDIRECT LIGHT OUTPUT
WITH OPAL DIFFUSER

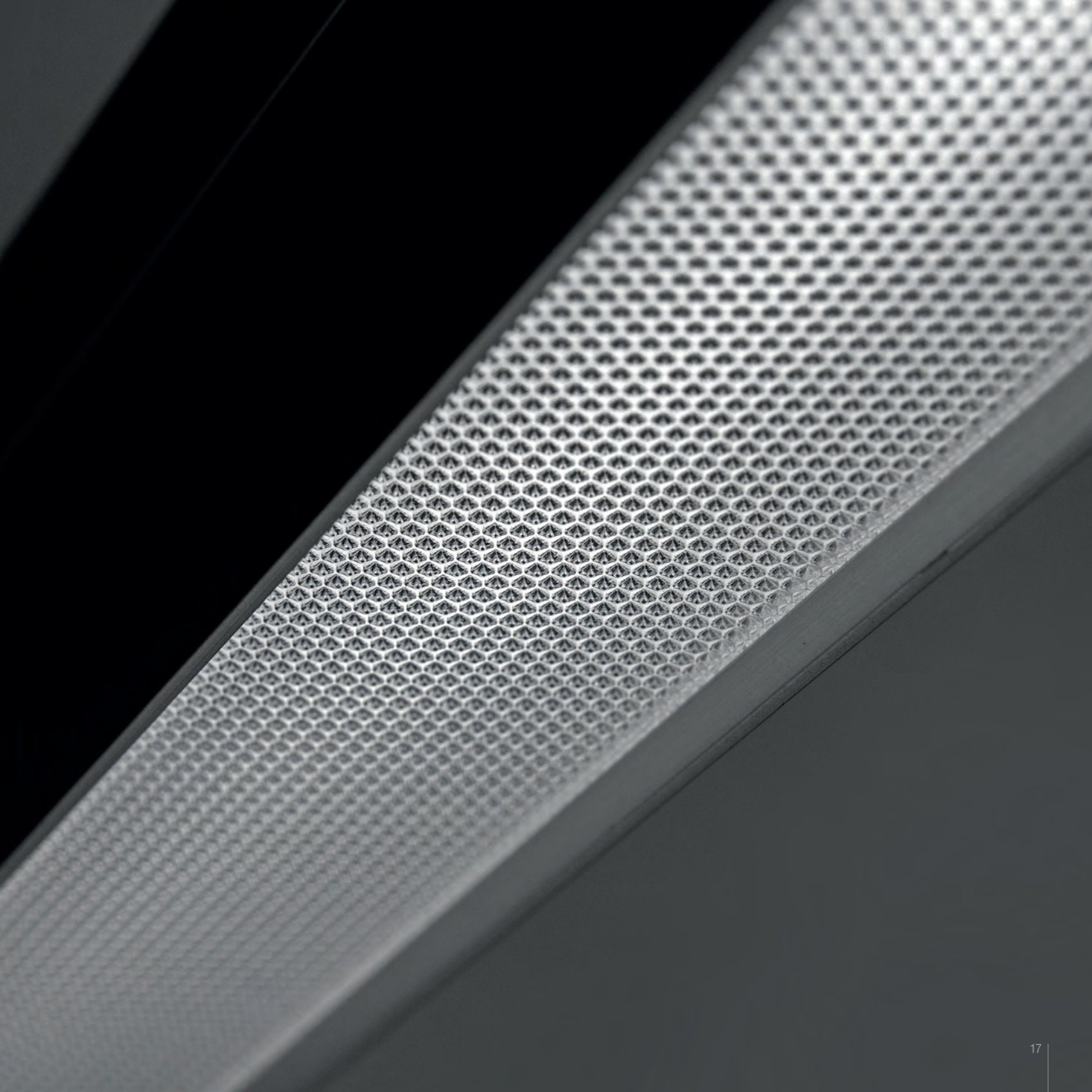

PALADIO PRISM 35

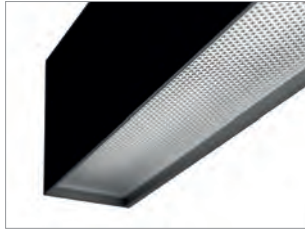

Design:
Ulrich Sattler

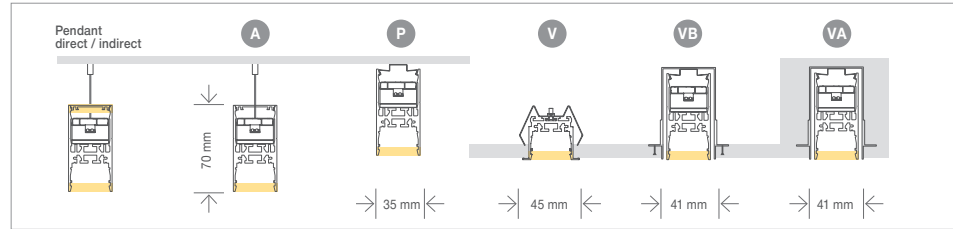

35 mm breites Aluminiumprofil mit hochwertiger gebürsteter und eloxierter Oberfläche in verschiedenen Farben. Pendel-, Anbau- und Einbauleuchte sowie randlose Einbauvariante möglich. Einsetzbar als individuelle Einzeleuchte oder Systemleuchte durch Verwendung von PALADIO CONNECT-Elementen (siehe Seite 40).

35 mm wide aluminium profile with high-quality brushed and anodised surface in different colours. Pendant, surface mounted and recessed mounted versions are available. Can be used as an individual single luminaire or system luminaire with PALADIO CONNECT elements (see page 40).

Maße / size: L x B x H

LED Watt
direct

Lumen
direct

Lumen
/ Watt

Art. Nr. / item No.
Einzeleuchte | Systemleuchte
Single | System

QR-Code
Datenblatt / Spec Sheet

1130 x 35 x 70 mm / 44.5 x 1.4 x 2.7"	20	2.080	106	2080 2280.0A.66.40.10.00.00.06.Z91
1410 x 35 x 70 mm / 55.5 x 1.4 x 2.7"	25	2.600	106	2081 2281.0A.66.40.10.00.00.06.Z91
2250 x 35 x 70 mm / 88.5 x 1.4 x 2.7"	39	4.160	106	2082 2282.0A.66.40.10.00.00.06.Z91
2810 x 35 x 70 mm / 110.6 x 1.4 x 2.7"	49	5.200	106	2083 2283.0A.66.40.10.00.00.06.Z91
3370 x 35 x 70 mm / 132.6 x 1.4 x 2.7"	59	6.240	106	2084 2284.0A.66.40.10.00.00.06.Z91
3930 x 35 x 70 mm / 154.7 x 1.4 x 2.7"	69	7.280	106	2085 2285.0A.66.40.10.00.00.06.Z91



STANDARD

 LED | CRI > 90 | neutralweiß / neutral white 4000 K

 DALI-2, switch Dim

 Direkt abstrahlend / direct light output

 bronze eloxiert / bronze anodised 66

 Zuleitung transparent / power supply cable transparent Z91

 Montageversion / Mounting version **A**

 Einzeleuchte / Single

 Mikrop Prismatik symmetrisch 65° / Mikroprismatic symmetrical 65°

OPTIONAL

3000 K, 2700 - 6500 K (tunable white)

 Als Systemleuchte ohne direkten Lichtaustritt
as system luminaire without direct light output

 Direkt | indirekt abstrahlend / direct | indirect light output

 60 62 65

P **V** **VB** **VA**

 Systemleuchte mit / System with PALADIO CONNECT

 Asymmetrisch 15°, 65° / asymmetrical 15°, 65°



PALADIO PRISM 35 | SINGLE
Pendelleuchte | Pendant | black
10 x 3370 mm | direct/indirect
Art.Nr. 2084.

PALADIO DOWNLIGHT
Einbauleuchte | recessed
9 x 300 mm | lens optic
Art.Nr. 2305.

PALADIO PRISM 54

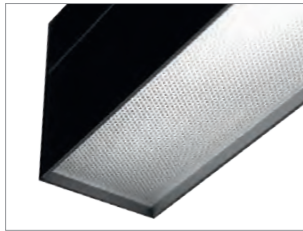

Design:
Ulrich Sattler

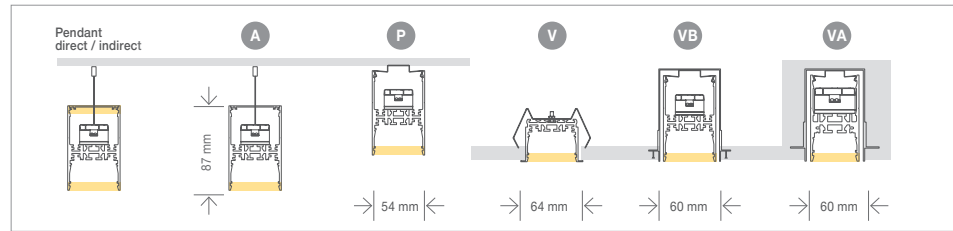









54 mm breites Aluminiumprofil mit hochwertiger gebürsteter und eloxierter Oberfläche in verschiedenen Farben. Pendel-, Anbau- und Einbauleuchte sowie randlose Einbauvariante möglich. Einsetzbar als individuelle Einzeleuchte oder Systemleuchte durch Verwendung von PALADIO CONNECT-Elementen (siehe Seite 40).

54 mm wide aluminium profile with high-quality brushed and anodised surface in different colours. Pendant, surface mounted and recessed mounted versions are available. Can be used as an individual single luminaire or system luminaire with PALADIO CONNECT elements (see page 40).







Maße / size: L x B x H

Maße / size: L x B x H	LED Watt direct	Lumen direct	Lumen / Watt	Art. Nr. / item No. Einzeleuchte Systemleuchte Single System	QR-Code Datenblatt / Spec Sheet
1130 x 54 x 87 mm / 44.5 x 2.1 x 3.4"	20	2.304	118	2070 2270.OA.66.40.10.00.00.06.Z91	
1410 x 54 x 87 mm / 55.5 x 2.1 x 3.4"	25	2.880	118	2071 2271.OA.66.40.10.00.00.06.Z91	
2250 x 54 x 87 mm / 88.5 x 2.1 x 3.4"	39	4.608	118	2072 2272.OA.66.40.10.00.00.06.Z91	
2810 x 54 x 87 mm / 110.6 x 2.1 x 3.4"	49	5.760	118	2073 2273.OA.66.40.10.00.00.06.Z91	
3370 x 54 x 87 mm / 132.6 x 2.1 x 3.4"	59	6.912	118	2074 2274.OA.66.40.10.00.00.06.Z91	
3930 x 54 x 87 mm / 154.7 x 2.1 x 3.4"	69	8.064	118	2075 2275.OA.66.40.10.00.00.06.Z91	

STANDARD

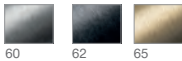
-  LED | CRI > 90 | neutralweiß / neutral white 4000 K
-  DALI-2, switch Dim
-  Direkt abstrahlend / direct light output
-  bronze eloxiert / bronze anodised 66
-  Zuleitung transparent / power supply cable transparent Z91
-  Montageversion / Mounting version **A**
-  Einzeleuchte / Single
-  **65°** Mikroprismatik symmetrisch 65° / Mikroprismatic symmetrical 65°

OPTIONAL

- 3000 K, 2700 - 6500 K (tunable white)
-  Als Systemleuchte ohne direkten Lichtaustritt
as system luminaire without direct light output
-  Direkt | indirekt abstrahlend / direct | indirect light output
-  60 62 65
-  **P** **V** **VB** **VA**
-  Systemleuchte für / System for PALADIO CONNECT
-  **65°** Asymmetrisch 15°, 65° / asymmetrical 15°, 65°



PALADIO PRISM 54 | SINGLE
Pendelleuchte | pendant | gold
1 x 3930 mm
Art.Nr. 2075

PALADIO DOWNLIGHT
Einbauleuchte | recessed
6 x 300 mm | lens optic
Art.Nr. 2305

PALADIO

A MODULAR SYSTEM

PALADIO LENS



Leuchten der PALADIO LENS Serie verfügen über hocheffiziente Mini-Linsenreflektoren. Dieses innovative System kombiniert die Vorteile von Linsen und Reflektoren miteinander. Dabei übernimmt die zurückversetzte Linse die Aufgabe der Lichtstromverteilung und der Reflektor reduziert zuverlässig die entstehende seitliche Blendung.

Durch diese extrem niedrigen Blendwerte entspricht die Leuchte der Norm EN 12464-1. Standardmäßig besitzen die Linsen einen Abstrahlwinkel von 60° oder optional 80°.

Luminaires of the PALADIO LENS series have highly efficient miniature lens reflectors. This innovative system combines the advantages of lenses and reflectors, with the recessed lens taking over the task of luminous flux distribution, while the reflector reliably reduces the resulting lateral glare.

Due to these extremely low glare values, the luminaire complies with the EN 12464-1 standard. By default, the lenses have a beam angle of 60° or optionally 80°.

DIRECT LIGHT OUTPUT

CRI >90

UGR <19

L90 | B10 | 72.000h

Effizienz /

Efficiency up to 78%

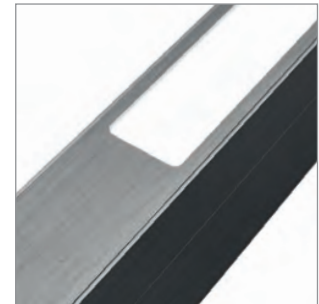

INDIRECT LIGHT OUTPUT
WITH OPAL DIFFUSER



PALADIO LENS 35

Deckeneinbau / recessed in ceiling

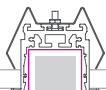

PALADIO LENS 35 | System
Deckeneinbau | recessed in ceiling
2 x 3370 mm
Art.Nr. 2284.

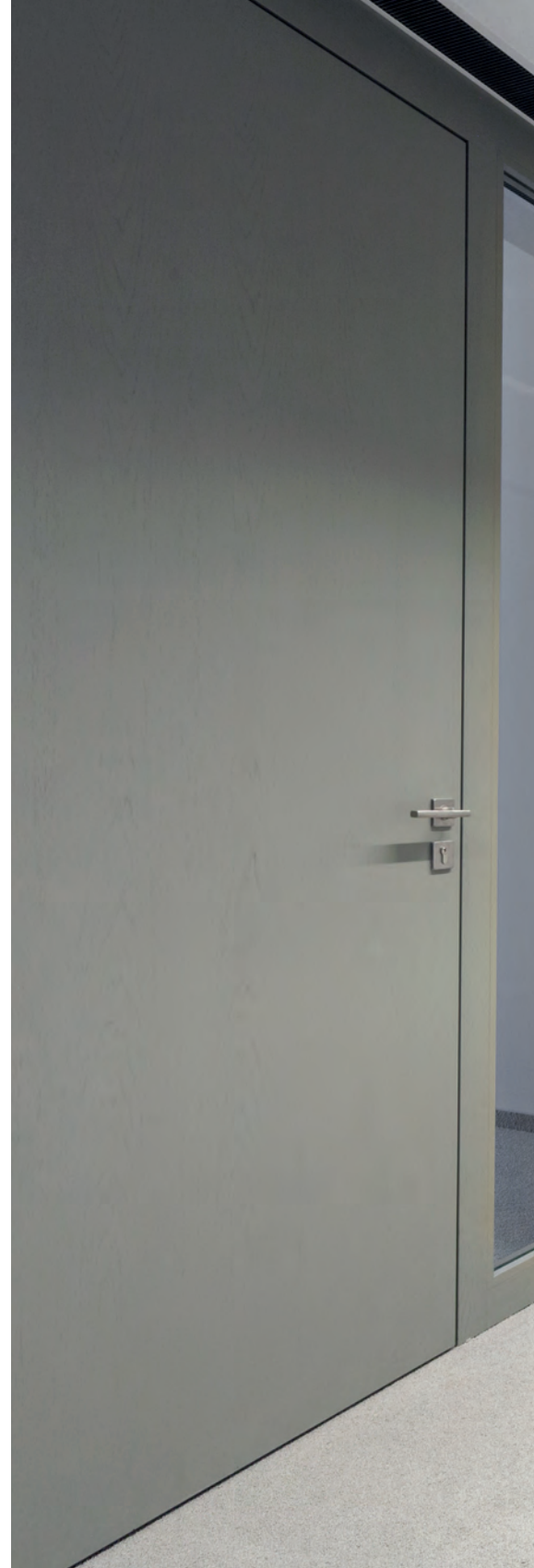



PALADIO LENS 35



Design:
Ulrich Sattler

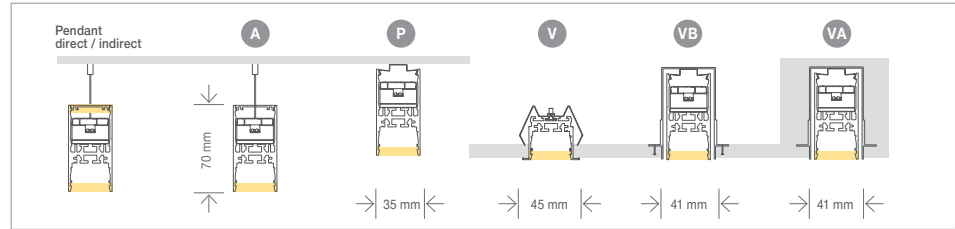









35 mm breites Aluminiumprofil mit hochwertiger gebürsteter und eloxierter Oberfläche in verschiedenen Farben. Pendel-, Anbau- und Einbauleuchte sowie randlose Einbauvariante möglich. Einsetzbar als individuelle Einzeleuchte oder Systemleuchte durch Verwendung von PALADIO CONNECT-Elementen (siehe Seite 40).

35 mm wide aluminium profile with high-quality brushed and anodised surface in different colours. Pendant, surface mounted and recessed mounted versions are available. Can be used as an individual single luminaire or system luminaire with PALADIO CONNECT elements (see page 40).





Maße / size: L x B x H

	LED Watt direct	Lumen direct	Lumen / Watt	UGR	Art. Nr. / item No. Einzeleuchte Systemleuchte Single System	QR-Code Datenblatt / Spec Sheet
1130 x 35 x 70 mm / 44.5 x 1.4 x 2.7"	17	1.907	115	<19	2080 2280 .0A.66.32.10.00.00.06.Z91	
1410 x 35 x 70 mm / 55.5 x 1.4 x 2.7"	17	1.907	115	<19	2081 .0A.66.32.10.00.00.06.Z91	
2250 x 35 x 70 mm / 88.5 x 1.4 x 2.7"	34	3.813	115	<19	2082 2282 .0A.66.32.10.00.00.06.Z91	
2810 x 35 x 70 mm / 110.6 x 1.4 x 2.7"	34	3.813	115	<19	2083 2283 .0A.66.32.10.00.00.06.Z91	
3370 x 35 x 70 mm / 132.6 x 1.4 x 2.7"	50	5.720	115	<19	2084 2284 .0A.66.32.10.00.00.06.Z91	
3930 x 35 x 70 mm / 154.7 x 1.4 x 2.7"	50	5.720	115	<19	2085 .0A.66.32.10.00.00.06.Z91	

STANDARD

-  LED | CRI > 90 | neutralweiß / neutral white 4000 K
-  DALI-2, switch Dim
-  Direkt abstrahlend / direct light output
-  bronze eloxiert / bronze anodised 66
-  Zuleitung transparent / power supply cable transparent Z91
-  Montageversion / Mounting version **A**
-  Einzeleuchte / Single
-  Mini Linsenreflektor 60° / Mini lens reflector 60°

OPTIONAL

- 3000 K, 2700 - 6500 K (tunable white)
-  Als Systemleuchte ohne direkten Lichtaustritt
as system luminaire without direct light output
-  Direkt | indirekt abstrahlend / direct | indirect light output
-  60 62 65
-  **P** **V** **VB** **VA**
-  Systemleuchte mit / System with PALADIO CONNECT



PALADIO LENS 35 | SINGLE
Pendelleuchte | Pendant | black
1 x 2810 mm
Art.Nr. 2083.

PALADIO DOWNLIGHT
Deckeneinbau | recessed in ceiling
2 x 300 mm | lens optic
Art.Nr. 2305.

PALADIO LENS 54

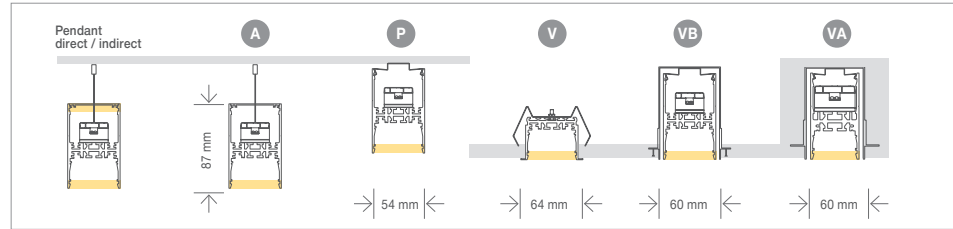

Design:
Ulrich Sattler

54 mm schmal überzeugt die filigrane PALADIO-Serie durch einen hochwertigen Aluminiumkörper mit edler Haptik. Verschiedene Längen und Montagevarianten eröffnen ein breites Anwendungsspektrum.

At only 54 mm wide, the exquisite PALADIO series impresses with its high-quality aluminium body with refined structural properties. Various lengths and mounting options open up a wide application range.

Maße / size: L x B x H

LED Watt
direct

Lumen
direct

Lumen
/ Watt

UGR

Art. Nr. / item No.
Einzelleuchte | Systemleuchte
Single | System

QR-Code
Datenblatt / Spec Sheet

1130 x 54 x 87 mm / 44.5 x 2.1 x 3.4"	16	2.128	139	<19	2070 2270.OA.66.40.32.00.00.06.Z91
1410 x 54 x 87 mm / 55.5 x 2.1 x 3.4"	16	2.128	139	<19	2071 .OA.66.40.32.00.00.06.Z91
2250 x 54 x 87 mm / 88.5 x 2.1 x 3.4"	31	4.256	139	<19	2072 2272.OA.66.40.32.00.00.06.Z91
2810 x 54 x 87 mm / 110.6 x 2.1 x 3.4"	31	4.256	139	<19	2073 2273.OA.66.40.32.00.00.06.Z91
3370 x 54 x 87 mm / 132.6 x 2.1 x 3.4"	47	6.384	139	<19	2074 2274.OA.66.40.32.00.00.06.Z91
3930 x 54 x 87 mm / 154.7 x 2.1 x 3.4"	47	6.384	139	<19	2075 .OA.66.40.32.00.00.06.Z91



STANDARD



LED | CRI > 80 | neutralweiß / neutral white 4000 K



DALI-2, switch Dim



Direkt abstrahlend / direct light output



bronze eloxiert / bronze anodised 66



Zuleitung transparent / power supply cable transparent Z91



Montageversion / Mounting version **A**



Einzelleuchte / Single



Linsenreflektor 60° / lens reflector 60°

OPTIONAL

3000 K, 2700 - 6500 K (tunable white)



Als Systemleuchte ohne direkten Lichtaustritt
as system luminaire without direct light output



Direkt | indirekt abstrahlend / direct | indirect light output



60



62



65



P



V



VB



VA



Systemleuchte mit / System with PALADIO CONNECT



Linsenreflektor 80° / lens reflector 80°



3 x PALADIO LENS 54 | System
Deckenanbau | direct ceiling mounted
black | 9 x 2810 mm
Art.Nr. 2273
black | 6 x 1130 mm
Art.Nr. 2270

PALADIO LENS 54
Pendelleuchte | Pendant
black | 1 x 3930 mm
Art.Nr. 2075

PALADIO

A MODULAR SYSTEM

PALADIO TRACK

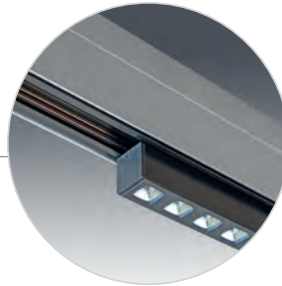

Die PALADIO TRACK bietet durch die integrierte 48V DALI-Stromschiene ein hohes Maß an Flexibilität und Gestaltungsfreiraum in der Planung.

Speziell entwickelte lineare Lichtelemente und ausgesuchte Leuchten aus dem SATTLER Portfolio lassen sich auf einfache Weise zu leistungsstarken Lichtsystemen, welche auch höchsten Designansprüchen genügen, kombinieren. Durch die Verbindungselemente PALADIO CONNECT lassen sich auch komplexeste Strukturen auf einfache Art und Weise realisieren.

The PALADIO TRACK with its integrated 48 V DALI power track offers a high degree of flexibility and design freedom.

Specially developed linear lighting elements and selected luminaires from the SATTLER portfolio can be easily combined to create high-performance lighting systems that also meet the highest design requirements.

With the PALADIO CONNECT connecting elements, even the most complex structures can be made in a simple manner.

SATTLER
LIGHT IN NEW DIMENSIONS

PALADIO TRACK 35 | System
Deckeneinbau / recessed in ceiling

2 x PALADIO CONNECT | 90°
connector
Art.Nr. 2240.

3 x AVVENI PENDANT 1
Art.Nr. 1211.

2 x AVVENI SPOT
Art.Nr. 1805.

4 x Light Element Reflector Opal
Art. Nr. 2006.

PALADIO TRACK 35

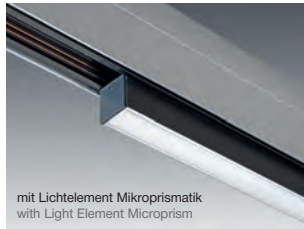

Design:
Ulrich Sattler

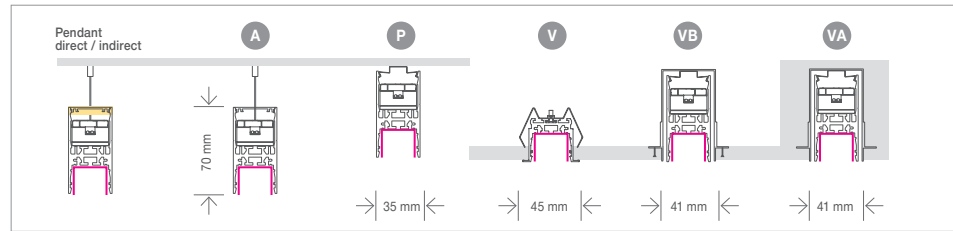

Einzel- oder Systemleuchte mit integrierter schwarzer DALI-Stromschiene (48V) zur flexiblen Bestückung mit linearen Lichtelementen oder Pendelleuchten und Spots für unterschiedlichste Anwendungen.

Single or system luminaires with an integrated black DALI power track (48 V) for flexible fitting with linear lighting elements, or pendant luminaires and spots for a variety of applications.

Maße / size: L x B x H

Art. Nr. / item No.
Einzelleuchte | Systemleuchte
Single | System

QR-Code
Datenblatt / Spec Sheet

1130 x 35 x 70 mm / 44.5 x 1.4 x 2.7"
1410 x 35 x 70 mm / 55.5 x 1.4 x 2.7"
2250 x 35 x 70 mm / 88.5 x 1.4 x 2.7"
2810 x 35 x 70 mm / 110.6 x 1.4 x 2.7"
3370 x 35 x 70 mm / 132.6 x 1.4 x 2.7"
3930 x 35 x 70 mm / 154.7 x 1.4 x 2.7"

2060 | **2260.0A.66.00.01.00.00.06.Z91**
2061 | **2261.0A.66.00.01.00.00.06.Z91**
2062 | **2262.0A.66.00.01.00.00.06.Z91**
2063 | **2263.0A.66.00.01.00.00.06.Z91**
2064 | **2264.0A.66.00.01.00.00.06.Z91**
2065 | **2265.0A.66.00.01.00.00.06.Z91**



STANDARD



DALI-2, switch Dim



kein indirekter Lichtaustritt | no indirect light output



bronze eloxiert / bronze anodised 66



Zuleitung transparent / power supply cable transparent Z91



Montageversion / Mounting version **A**



Einzelleuchte / Single

OPTIONAL

Blindabdeckung für Trackbereich /
Blind cover for the tracking area

indirect - 4000 K, 3000 K, 2700-6500 K (tunable white)



indirekt abstrahlend (opaler Diffusor) / indirect light
output (opal diffuser) | not available for L = 1130 mm



60

62

65



Systemleuchte mit / System with PALADIO CONNECT



SLIM direct Ø 1900 mm

PALADIO TRACK 35 | System
Deckenanbau | direct ceiling mounted

5 x FINO SPOT | Art.Nr. 1538.

PALADIO TRACK 35 | System
Deckeneinbau | recessed
4 x 2250mm | Art.Nr. 2262

1 x PALADIO CONNECT | 90° connector
Art.Nr. 2240.

4 x FINO SPOT | Art.Nr. 1538.

3 x AVVENI PENDANT 1 | Art.Nr. 1211.

2 x AVVENI SPOT | Art.Nr. 1805.

2 x Light Element Reflector | Art.Nr. 2011.

PALADIO TRACK 35 | Light Elements

Lineare Lichtelemente in schwarz für PALADIO TRACK (Stromschiene DC 48V DALI, schwarz)
Black linear light elements for PALADIO TRACK (power track DC 48 V DALI, black)

Reflektoren / Reflectors

Reflektoren / Reflectors
240° schwenkbar / tiltable

Mikroprisma / Microprism

Opal / Opal

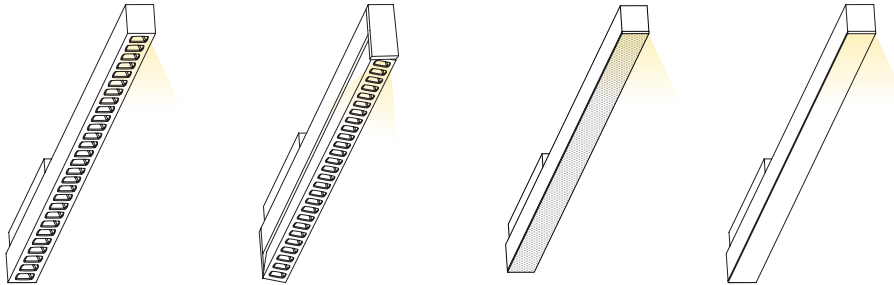



Mittels integriertem magnetischem Adapter lassen sich Lichtelemente mit Reflektor, Mikroprisma oder opalem Diffusor an der 48V DALI-Stromschiene des PALADIO Profils beliebig positionieren.

The integrated magnetic adapter allows any positioning of light elements with the reflector, microprism, or opal diffuser on the 48 V DALI power track of the PALADIO profile.

Maße / size: L x B x H	LED Watt	Lumen	CRI	UGR	Abstrahlwinkel beam angle	Art. Nr. / item No.	QR-Code Datenblatt / Spec Sheet	
Lichtelement mit Reflektor / Light element with reflector								
286 x 22 x 25 mm / 11.2 x 0.9 x 1.0"	5,2	492	95	<19	60°	2011.		
567 x 22 x 25 mm / 22.3 x 0.9 x 1.0"	9,9	984	95	<19	60°	2012.		
Lichtelement mit Reflektor 240° schwenkbar / Light element with reflector 240° tiltable								
590 x 22 x 50 mm / 11.2 x 0.9 x 1.0"	9,9	984	95	<19	60°	2022.		
Lichtelement mit Mikroprisma / Light element with microprism								
567 x 22 x 25 mm / 22.3 x 0.9 x 1.0"	11,9	1620	90	<25	67°	2017.		
1128 x 22 x 25 mm / 44.4 x 0.9 x 1.0"	23,8	3240	90	<25	67°	2019.		
Lichtelement mit opaler Abdeckung / Light element with opal diffuser								
567 x 22 x 25 mm / 22.3 x 0.9 x 1.0"	11,9	1620	90	<29	95°	2007.		
1128 x 22 x 25 mm / 44.4 x 0.9 x 1.0"	23,8	3240	90	<29	95°	2009.		

STANDARD

-  LED 48V | neutralweiß / neutral white 4000 K
-  Dimmung über NV-Stromschiene, DALI-2 /
Dimming via NV-power track, DALI-2
-  schwarz / black similar 62

OPTIONAL

3000 K

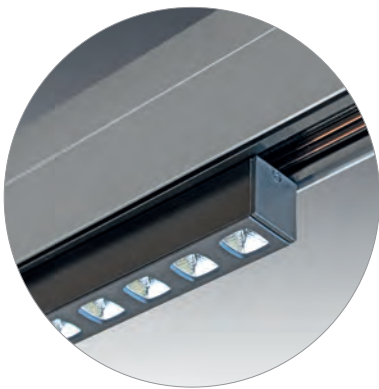

Reflektor / Reflector

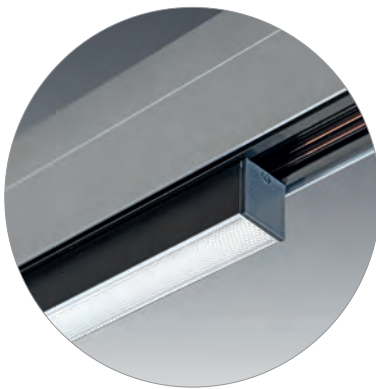

Mikroprisma / Microprism

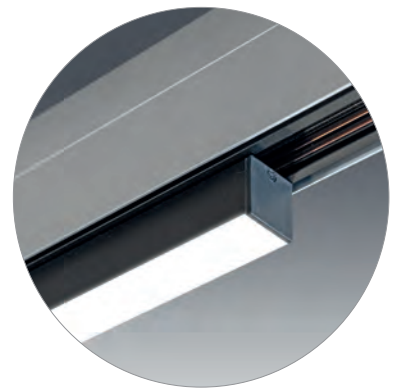

Opaler Diffusor / Opal diffuser

PALADIO TRACK 35 | Light Elements

Spots und Pendelleuchten für PALADIO TRACK (Stromschiene DC 48V DALI, schwarz) mittels Adapter
Spots and pendant luminaires for PALADIO TRACK (power track DC 48 V DALI, black) with adapter.

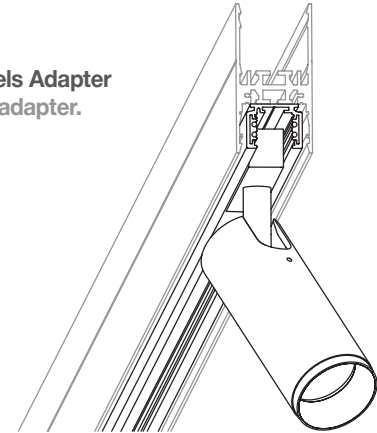
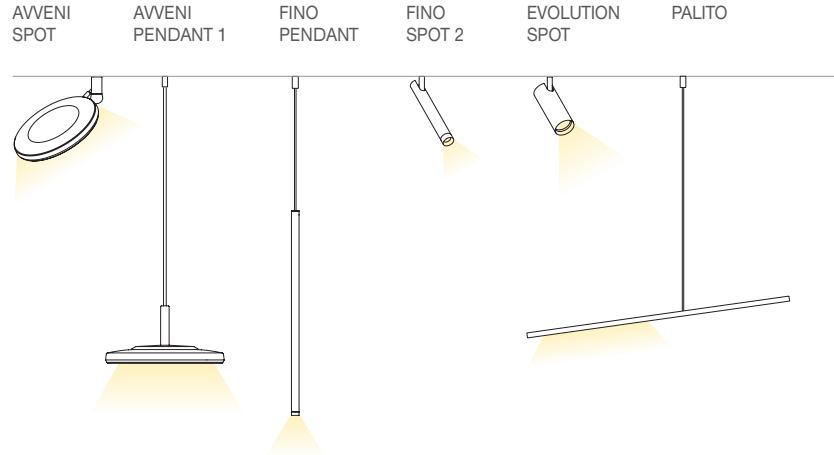

Anbauleuchten des SATTLER Portfolios, wie FINO SPOT, FINO PENDANT, PALITO, EVOLUTION SPOT und AVVENI PENDANT, können mittels des magnetischen Adapters am PALADIO TRACK Leuchtenprofil frei positioniert werden.

Surface-mounted lights from the SATTLER portfolio, such as the FINO SPOT, FINO PENDANT, PALITO, EVOLUTION SPOT and the AVVENI PENDANT, can be freely positioned on the PALADIO TRACK luminaire profile by use of the magnetic adapter.

Maße / size: L x B x H

LED Watt Lumen

Art. Nr. / item No.

QR-Code
Datenblatt / Spec Sheet

AVVENI SPOT

Ø 134 x H 101 mm

17 1344

1805.

AVVENI PENDANT 1

Ø 134 x H 101 mm

17 1344

1211.

FINO PENDANT

Ø 22 x L 600 mm

5 365

1533.

Ø 22 x L 800 mm

5 365

1534.

Ø 22 x L 1240 mm

5 365

1535.

Ø 22 x L 1550 mm

5 365

1536.

FINO SPOT 2

Ø 22 x L 165 mm

5 365

1539.

EVOLUTION SPOT

24° Ø 42 x L 110 mm

7 858

1778.

38° Ø 42 x L 110 mm

7 858

1779.

PALITO

Ø 22 x L 1240 mm

15 1514

1541.

Ø 22 x L 1550 mm

22 2270

1542.





PALADIO TRACK 35 | System
Deckenanbau | direct ceiling mounted

1 x PALADIO CONNECT
90° connector | Art.Nr. 2240.

8 x EVOLUTION SPOT
Art.Nr. 1778.

PALADIO TRACK 35 | System
Deckenanbau | direct ceiling mounted

2 x EVOLUTION SPOT
Art.Nr. 1778.

2 x AVVENI PENDANT 1
Art.Nr. 1211.

PALADIO TRACK 35

Deckenanbau / direct ceiling mounted

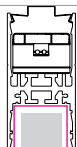

PALADIO TRACK 35 | System
Deckenanbau | direct ceiling mounted
1 x PALADIO CONNECT | 90° connector | Art.Nr. 2240.
3 x FINO PENDANT | Art.Nr. 1533.
2 x Light Element Reflector | Art.Nr. 2012.
3 x FINO SPOT | Art.Nr. 1538.





PALADIO

A MODULAR SYSTEM

PALADIO CONNECT

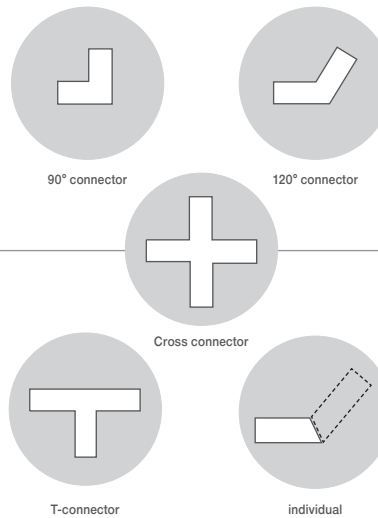

Die Linear- und Winkelverbinder des PALADIO CONNECT Programms ermöglichen die kreative Kombination von Systemleuchten aus den Serien PALADIO PRISM, LENS und TRACK. Hierdurch ergibt sich die Möglichkeit komplexe, raumübergreifende Strukturen auf einfache Art und Weise zu generieren und auf räumliche Gegebenheiten zielgerichtet einzugehen.

Die CONNECT-Verbinder sind in der Variante PRISM oder als Elemente mit Blindabdeckung verfügbar und ermöglichen durch die interne 230V-Verdrahtung Systemlängen von bis zu 40m.

The linear and angular connectors of the PALADIO CONNECT range permit the creative combination of system luminaires from the PALADIO PRISM, LENS and TRACK series. This provides the opportunity to generate complex, room-spanning structures in a simple manner and to address spatial conditions in a targeted way.

The CONNECT elements are available in the PRISM version or as elements with a blind cover. With their internal 230 V wiring, they permit system lengths of up to 40 m.



K-A3

PALADIO PRISM 35 | System
Deckenanbau | direct ceiling mounted

2 x PALADIO CONNECT
120° connector | Art. Nr. 2241.

PALADIO CONNECT

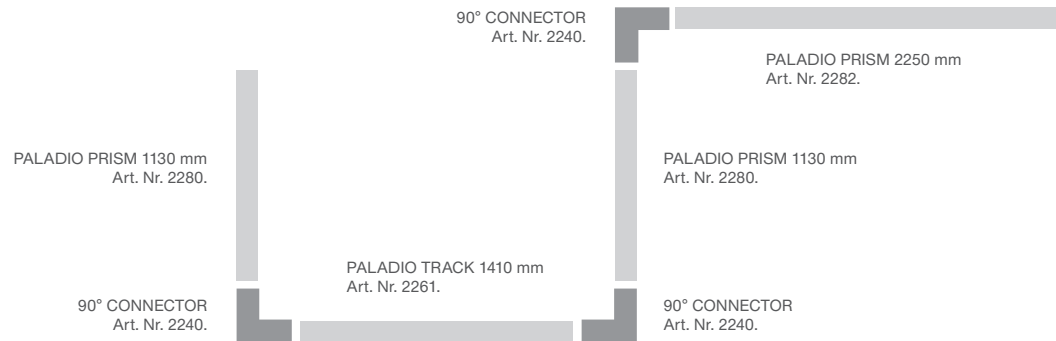

PALADIO CONNECT Elemente sind Verbindungselemente für die Serie PALADIO PRISM, LENS und TRACK Systemleuchten. Sie ermöglichen es komplexe Strukturen innerhalb der jeweiligen Serie oder aber auch zwischen den Serien PRISM, LENS und TRACK zu schaffen. Verbindungselemente für PALADIO LENS und TRACK Systeme sind immer direkt und indirekt mit Blindabdeckungen versehen. PALADIO PRISM Verbindungselemente sind funktional und beinhalten ein eigenes 230V Netzteil. Alle Elemente können jedoch immer nur innerhalb eines gesamten Systems betrieben werden.

PALADIO CONNECT elements are connectors for the PALADIO PRISM, LENS and TRACK system luminaire series. They make it possible to create complex structures within the respective series or between the PRISM, LENS and TRACK series. Connection elements for PALADIO LENS and TRACK systems are always directly and indirectly applied with blind covers. PALADIO PRISM connection elements are functional and contain their own 230 V power supply. All elements can, however, only be operated within a complete system.

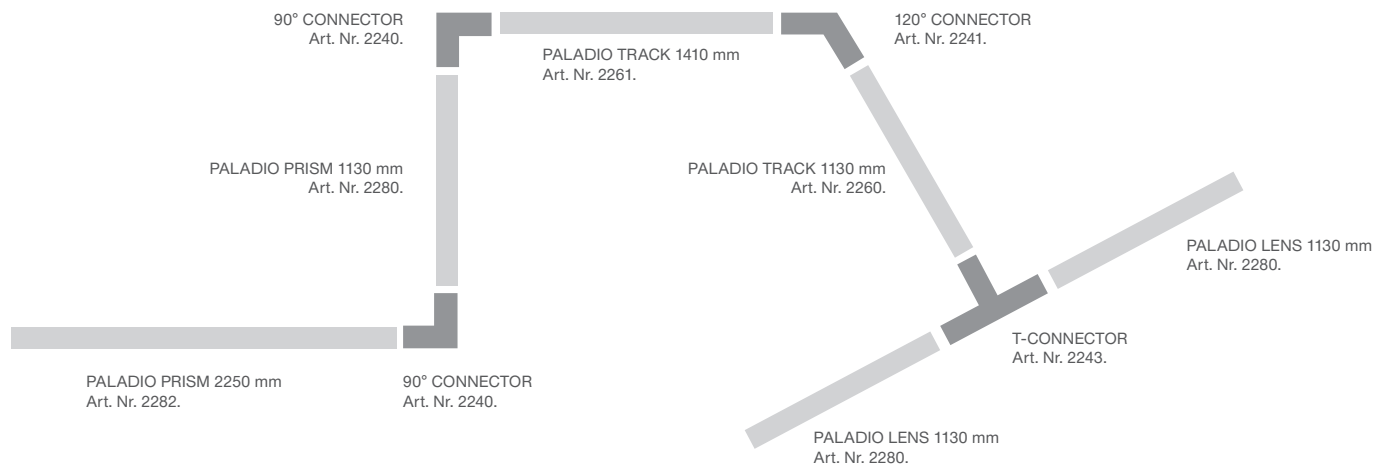



PALADIO CONNECT 35



Design:
Ulrich Sattler

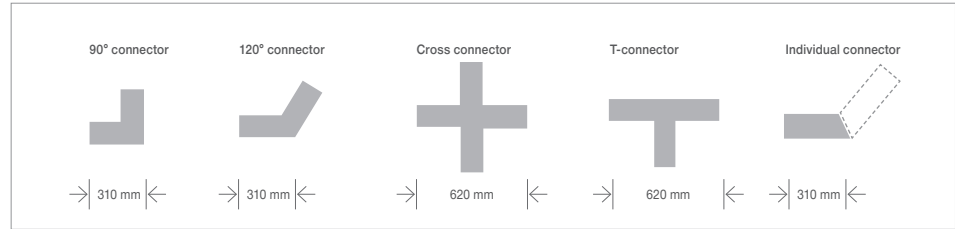

PALADIO CONNECT Verbindungselemente sind immer direkt und indirekt mit Blindabdeckungen versehen. PALADIO PRISM Verbindungselemente sind funktional und beinhalten ein eigenes 230V Netzteil.

PALADIO CONNECT elements are always directly and indirectly equipped with blind covers. PALADIO PRISM connection elements are functional and contain their own 230 V power supply.

CONNECT TYPE	LED Watt direct PRISM	Lumen direct PRISM	Art. Nr. / item No.	QR-Code Datenblatt / Spec Sheet
90° Verbinder / 90° connector	10	1.040	2240.OA.66.00.00.00.06.000	
120° Verbinder / 120° connector	10	1.040	2241.OA.66.00.00.00.00.06.000	
Kreuz-Verbinder / Cross connector	20	2.080	2242.OA.66.00.00.00.00.06.000	
T-Verbinder / T-connector	15	1.560	2243.OA.66.00.00.00.00.06.000	
Verbinder individuell / individual connector	10	1.040	2244.OA.66.00.00.00.00.06.000	

STANDARD

Blindabdeckung nach oben und unten. /
Blind cover on top and bottom.



bronze eloxiert / bronze anodised 66



Keine Zuleitung notwendig, Verdrahtung mit Systemleuchte.
No supply line needed, wiring with system luminaire.



Montageversion / Mounting version **A**

OPTIONAL



LED Direkt, 24V | CRI > 90 | 4000 K, 3000 K, 2700-6500 K



DALI-2, switch Dim



Option PALADIO PRISM: Direkt abstrahlend / direct light output



60



62



65



P



V



PALADIO CONNECT 35
90° Connector | Art.Nr. 2240

Darstellung im Bild als Verbindungselement mit Blindabdeckung + PALADIO LENS 35 Systemleuchte.
Shown in the image as connection element with blind cover + PALADIO LENS 35 system luminaire.

PALADIO CONNECT 54

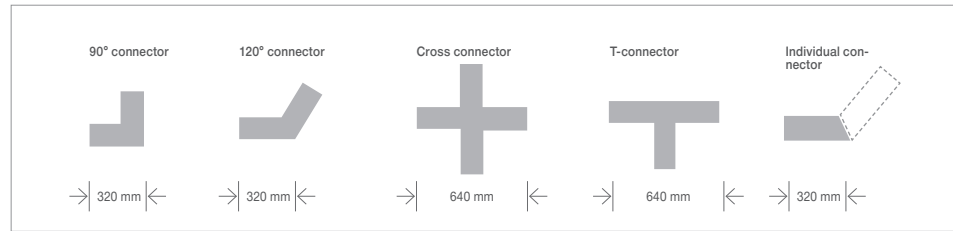
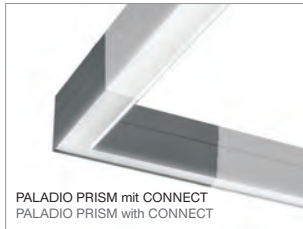

Design:
Ulrich Sattler

PALADIO CONNECT Verbindungselemente sind immer direkt und indirekt mit Blindabdeckungen versehen. PALADIO PRISM Verbindungselemente sind funktional und beinhalten ein eigenes 230V Netzteil.

PALADIO CONNECT elements are always directly and indirectly applied with blind covers. PALADIO PRISM connection elements are functional and contain their own 230 V power supply.

CONNECT TYPE	LED Watt direct PRISM	Lumen direct PRISM	Art. Nr. / item No.	QR-Code Datenblatt / Spec Sheet
90° Verbinder / 90° connector	10	1.152	2230.0A.66.00.00.00.06.000	
120° Verbinder / 120° connector	10	1.152	2231.0A.66.00.00.00.00.06.000	
Kreuz-Verbinder / Cross connector	20	2.304	2232.0A.66.00.00.00.00.06.000	
T-Verbinder / T-connector	15	1.728	2233.0A.66.00.00.00.00.06.000	
Verbinder individuell / individual connector	10	1.152	2234.0A.66.00.00.00.00.06.000	

STANDARD

Blindabdeckung nach oben und unten. /
Blind cover on top and bottom.



bronze eloxiert / bronze anodised 66



Keine Zuleitung notwendig, Verdrahtung mit Systemleuchte.
No supply line needed, wiring with system luminaire.



Montageversion / Mounting version **A**

OPTIONAL



LED Direkt, 24V | CRI > 90 | 4000 K, 3000 K, 2700-6500 K



DALI-2, switch Dim



Option PALADIO PRISM: Direkt abstrahlend / direct light output



60



62



65





PALADIO CONNECT 54
90° Connector | Art.Nr. 2230

Darstellung im Bild als funktionales PALADIO PRISM Verbindungselement (direkt abstrahlend) + PALADIO PRISM 54 Systemleuchte.
Shown in the image as functional PALADIO PRISM connection element (direct light output) + PALADIO PRISM system luminaire.

PALADIO DOWNLIGHT

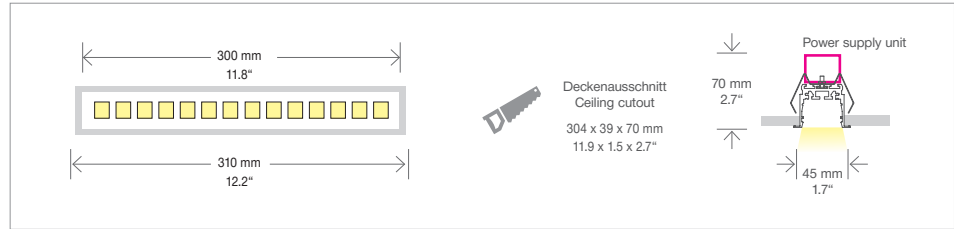
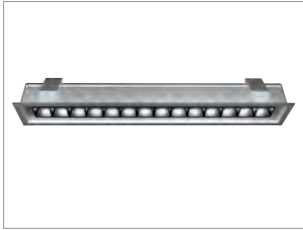

Design:
Ulrich Sattler

Einbau-Downlight, Länge 30 cm, mit 60° Mini Linsenreflektoren inkl. Netzteil
Recessed downlight, length 30 cm, with 60° mini lens reflectors incl. power supply.

Maße / size: L x B x H

LED Watt

Lumen

Abstrahlwinkel
Beam angle

Art. Nr.
item No.

QR-Code
Datenblatt / Spec Sheet

300 x 45 x 70 mm / 11.8 x 1.7 x 2.7"

10

1.170

60°

2305.0V.60.40.32.00.00.06.000



STANDARD



CRI > 90 | neutralweiß / neutral white 4000 K



DALI-2, Switch Dim



Direkt abstrahlend / direct light output



silber / silver 60



Montageversion / Mounting version



Mini Linsenreflektor 60° / Mini lens reflector 60°

OPTIONAL

3000 K, 2700 - 6500 K (tunable white)

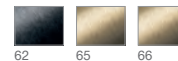



PALADIO WALL

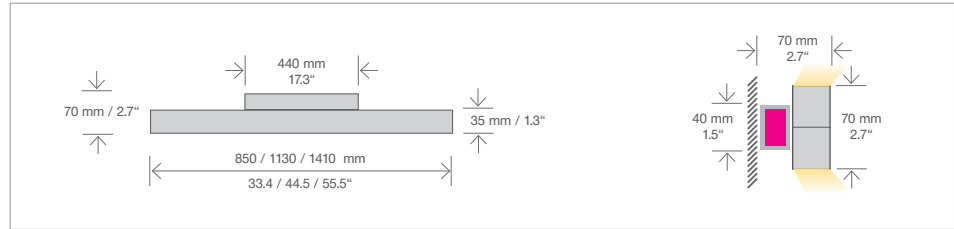
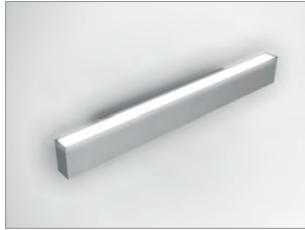

Design:
Ulrich Sattler

Wandleuchte in 3 Längen, direkt/indirekt, mit Wandbefestigung und integriertem Netzteil
Wall luminaire in 3 lengths, direct/indirect, with fixation elements and integrated power supply

Maße / size: L x B x H

LED Watt
direct /indirect

Lumen
direct /indirect

Abstrahlwinkel
Beam angle

Art. Nr.
item No.

QR-Code
Datenblatt / Spec Sheet

Maße / size: L x B x H	LED Watt direct /indirect	Lumen direct /indirect	Abstrahlwinkel Beam angle	Art. Nr. item No.
850 x 35 x 70 mm / 33.4 x 1.3 x 2.7"	15 / 15	1.560 / 1.440	15°, 65°	2300 .0P.66.40.20.40.20.06.000
1130 x 35 x 70 mm / 44.5 x 1.3 x 2.7"	20 / 20	2.080 / 1.920	15°, 65°	2301 .0P.66.40.20.40.20.06.000
1410 x 35 x 70 mm / 55.5 x 1.3 x 2.7"	25 / 25	2.600 / 2.400	15°, 65°	2302 .0P.66.40.20.40.20.06.000



STANDARD



LED CRI > 90 | neutralweiß / Neutral-white 4000 K



DALI-2, Switch Dim



Direkt/Indirekt abstrahlend / direct/indirect light output



bronze eloxiert / bronze anodised 66



Montageversion / Mounting version **P**



Mikroprismatik asymmetrisch 15°, 65° Abstrahlwinkel /
Microprism asymmetrical 15°, 65° beam angle

OPTIONAL

3000 K, 2700 - 6500 K (tunable white)

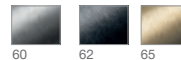



PALADIO WALL | 1130 mm
special colour white
Art.Nr. 2301.

BE2 | 118 x 118 mm | black
Art.Nr. 1017.

COVE LIGHTING

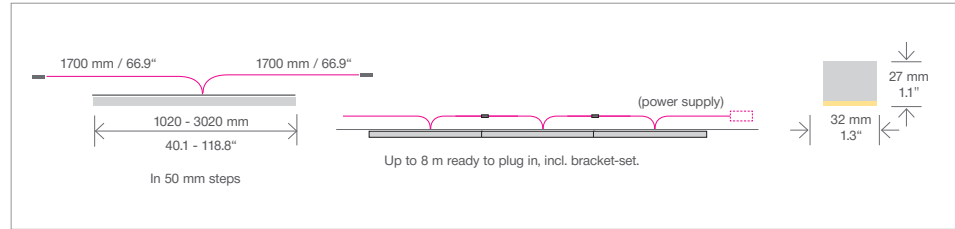

Design:
Ulrich Sattler

Hinterleuchtung oder Voutenbeleuchtung an die gegebene Architektur in 50 mm Schritten anpassbar.
Cove lighting can be adapted to the given architecture in 50 mm steps as backlighting or cove lighting.

Maße / size: L x B x H

LED Watt

Lumen

Art. Nr.
item No.

QR-Code
Datenblatt / Spec Sheet

1020 - 3020 x 32 x 27 mm
40.1 - 118.8 x 1.3 x 1.1"

18 W/m

1.172

1180.30.61.00.21.904.G



Zwischenmaße alle 50 mm abstufbar.
Intermediate dimensions are available in steps of 50 mm.

STANDARD



LED 24V | CRI > 90 | warmweiß / warm-white 3000 K



DALI, Switch Dim, ready2mains™



Direkt abstrahlend / direct light output



alu natur / anodised 21



Montageversion / Mounting version **G**

OPTIONAL

2700 K, 4000 K

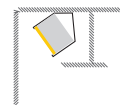
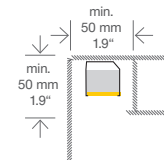
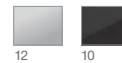

Netzteil separat bestellbar / Power supply can be ordered separately

60 W bis zu / up to 3000 mm
100 W bis zu / up to 5000 mm
150 W bis zu / up to 8000 mm

277.00.00.00.00
278.00.00.00.00
279.00.00.00.00

Standard
Befestigungs-
klammer
Clamp **45°/90°**

Optional
Befestigungs-
klammer
Clamp **30°/60°**



Project: Medical Practice Dr. Bernas
Architect: Architekturbüro Scheer
und Wahl, Eislingen
Planner: Mayer Innenarchitektur &
Möbelmanufaktur

Cove Lighting | 26,5 m
Art.Nr. 1180

AVVENI DOWNLIGHT with frame
Art.Nr. 1116.

AVVENI PENDANT 8
Art.Nr. 1140.

DOWNLIGHTS SPOTS

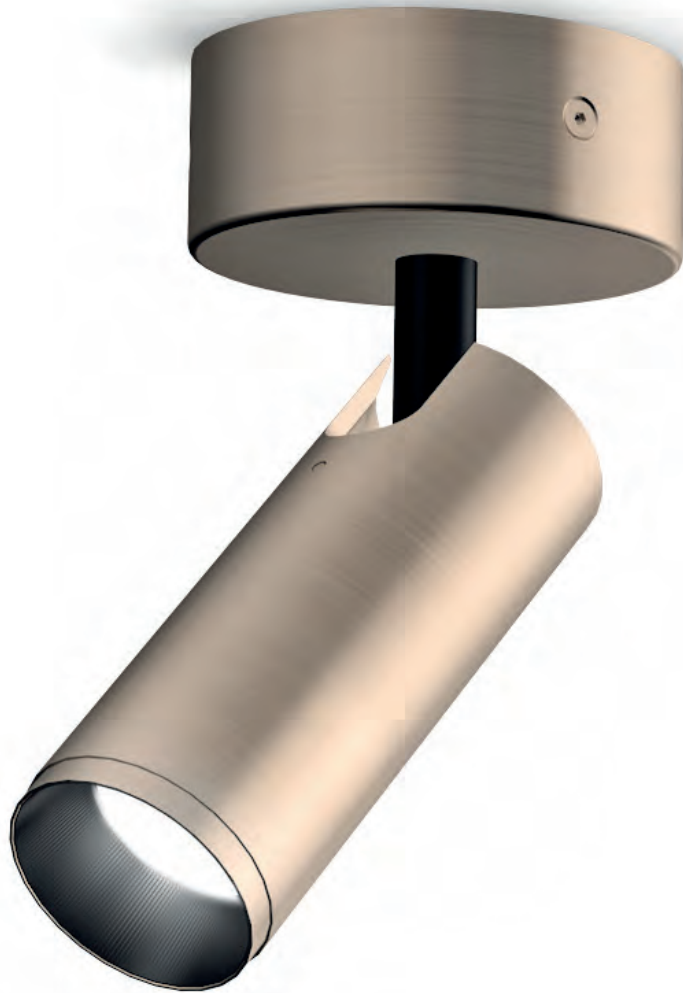

EVOLUTION SPOT



Design:
Ulrich Sattler

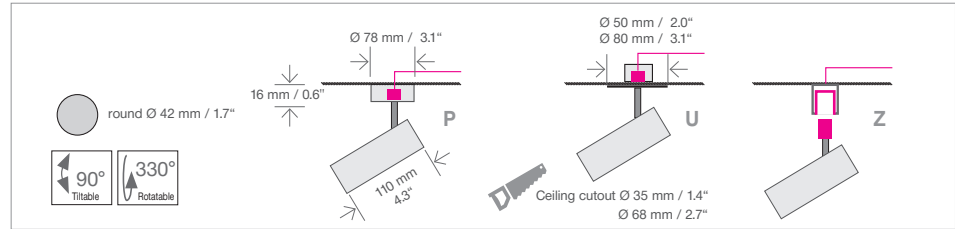

Spot 330° schwenkbar, wahlweise mit 24° oder 38° Abstrahlwinkel, inkl. Netzteil.
Spot swivels 330°, with beam angles of 24° or 38°, including power supply.

Maße / size: Ø x L

LED Watt

Lumen

Abstrahlwinkel
Beam angle

Art. Nr.
item No.

QR-Code
Datenblatt / Spec Sheet

Ø 42 x 110 mm / 1.7 x 4.3"

6,3

858

24°
38°

1778.30.11.00.66.000.P
1779.30.11.00.66.000.P



STANDARD



LED | CRI > 90 | warmweiß / warm white 3000 K



TRIAC



Direkt abstrahlend / direct light output



bronze eloxiert / bronze anodised 66



Montageversion / Mounting version **P**



OPTIONAL

2700 K, 4000 K

DALI

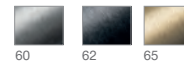

U Blende Ø 50 mm / Deckenausschnitt 35 mm
Technikeinheit in Zwischendecke

Blende Ø 80 mm / Deckenausschnitt 68 mm
Technikeinheit in Einbaudose

Cover Ø 2.0" / Ceiling cutout 1.4"
Power supply unit in suspended ceiling

Cover Ø 3.1" / Ceiling cutout 2.7"
Power supply unit in cavity box

EVOLUTION

Siehe Katalog Light In New Dimensions 2
See catalogue Light In New Dimensions 2



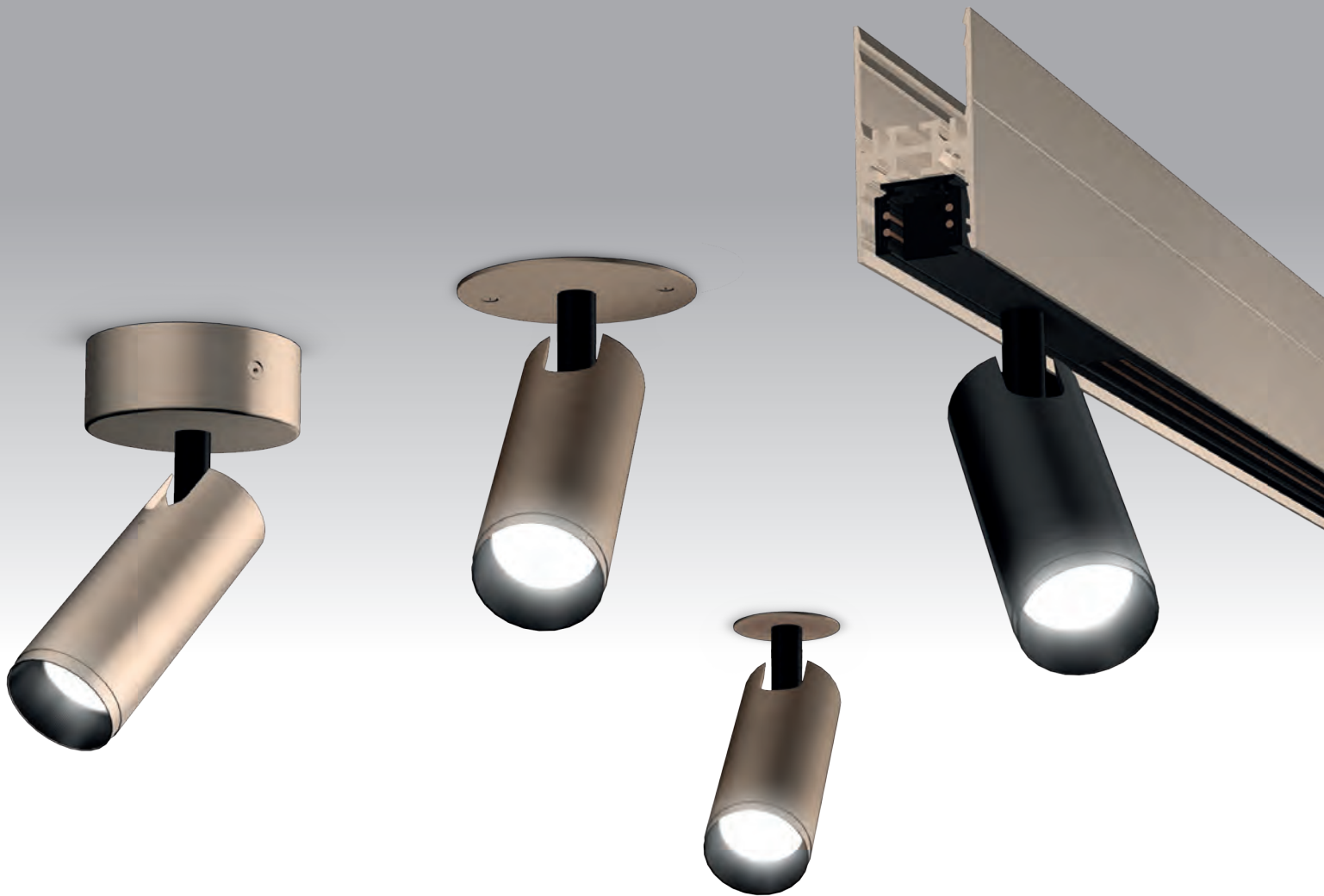

EVOLUTION SPOT in 4 verschiedenen Montageversionen
Deckenanbau | Deckeneinbau | Mit Adapter zur Verwendung an PALADIO TRACK 48V DALI-Stromschiene

EVOLUTION SPOT in 4 different mounting options
Direct ceiling mounted | recessed in ceiling | With adapter for use on the PALADIO TRACK 48 V DALI power track

EVOLUTION CEILING

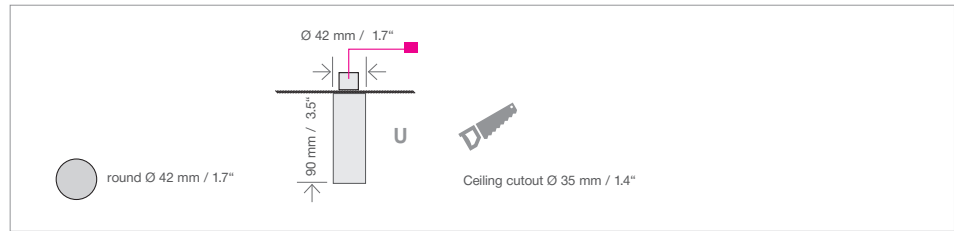

Design:
Ulrich Sattler

Reduzierter, eleganter Anbau-Spot der Leuchtenserie Evolution.
Reduced, elegant surface-mounted spot of the Evolution luminaire series

Maße / size: Ø x H

LED Watt

Lumen

Art. Nr.
item No.

QR-Code
Datenblatt / Spec Sheet

Ø 42 x 90 mm / 1.7 x 3.5"

6,3

858

1777.30.00.00.66.000.U



STANDARD



LED 24V | CRI > 90 | warmweiß / Warm-white 3000 K



ohne Dimmung / without dimmer



Direkt abstrahlend / direct light output



bronze eloxiert / bronze anodised 66



Montageversion / Mounting version **U**

OPTIONAL

2700 K, 4000 K

DALI, TRIAC

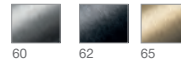

EVOLUTION

Siehe Katalog Light In New Dimensions 2
See catalogue Light In New Dimensions 2



EVOLUTION CEILING | Art.Nr. 1777.

BE 1



Einbau-Downlight, mit runder oder quadratischer Blende und mit 24° oder 36° Abstrahlwinkel, inkl. Netzteil.
Downlight, with square and round frames and beam angles of 24° and 36°, incl. power supply.

Maße / size: L x B / Ø	LED Watt	Lumen	Abstrahlwinkel Beam angle	Art. Nr. item No.	QR-Code Datenblatt / Spec Sheet
86 x 86 mm / 3.4 x 3.4"	9	840	24°	1501.40.01.00.12.000.V	
86 x 86 mm / 3.4 x 3.4"	9	840	36°	1502.40.01.00.12.000.V	
Ø 86 mm / 3.4"	9	840	24°	1503.40.01.00.12.000.V	
Ø 86 mm / 3.4"	9	840	36°	1504.40.01.00.12.000.V	

STANDARD

LED 24V | CRI > 90 | neutralweiß / Neutral-white 4000 K

ohne Dimmung / without dimmer

Direkt abstrahlend / direct light output

weiß pulverbeschichtet / white powder coated 12

Montageversion / Mounting version



OPTIONAL

2700 K, 3000 K

DALI, Switch Dim, ready2mains™

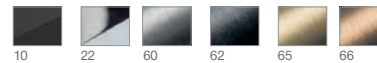



Project: Medical Practice Dr. Bernas
Architect: Architekturbüro Scheer
und Wahl, Eislingen
Planner: Mayer Innenarchitektur &
Möbelmanufaktur

BE 1 | 86 x 86 mm
Art.Nr. 1502.

AVVENI DOWNLIGHT with frame
Art.Nr. 1116.

AVVENI PENDANT 8
Art.Nr. 1140.

BE 2



Einbau-Downlight, wahlweise quadratisch oder rund mit 18°, 30° oder 55° Abstrahlwinkel, inkl. Netzteil. Leuchte und Netzteil mit Steckverbindung. Durch anpassbare Blende auch ideal als Sanierungsdownlight zu verwenden.

Downlight with square and round frames and radiation angles of 18°, 30°, or 55°, incl. power supply. Luminaire and power supply with plug connection. Can also be used as a „renovation downlight“ with the adjustable cover.

Maße / size: L x B / Ø	LED Watt	Lumen	Abstrahlwinkel Beam angle	Art. Nr. item No.	QR-Code Datenblatt / Spec Sheet
118 x 118 mm / 4.6 x 4.6"	18	2.000	18°	1016.40.01.00.12.000.V	
118 x 118 mm / 4.6 x 4.6"	18	2.000	30°	1017.40.01.00.12.000.V	
118 x 118 mm / 4.6 x 4.6"	18	2.000	55°	1018.40.01.00.12.000.V	
Ø 118 mm / 4.6"	18	2.000	18°	1510.40.01.00.12.000.V	
Ø 118 mm / 4.6"	18	2.000	30°	1511.40.01.00.12.000.V	
Ø 118 mm / 4.6"	18	2.000	55°	1512.40.01.00.12.000.V	

STANDARD

LED 24V | CRI > 97 | neutralweiß / Neutral-white 4000 K

ohne Dimmung / without dimmer

Direkt abstrahlend / direct light output

weiß pulverbeschichtet / white powder coated 12

Montageversion / Mounting version



OPTIONAL

2700 K, 3000 K

DALI, Switch Dim, ready2mains™, CASAMBI, ENOCEAN wireless push button

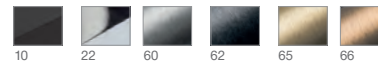

210.00.00.00.00 IP 44 Aufrüstung / upgrade

Sondermaße der Blenden sind auf Anfrage möglich.
Custom frame measures on request.



Project: Stadthalle Kassel

BE 2 | Ø 118 mm | Art.Nr. 1017.

BE3



Einbau-Downlight, wahlweise quadratisch oder rund mit 11°, 20°, 47° oder asymmetrischem Abstrahlwinkel, inkl. Netzteil. Leuchte und Netzteil mit Steckverbindung. Durch anpassbare Abdeckung auch ideal als Sanierungsdownlight zu verwenden.

Downlight, with square and round frames and radiation angles of 11°, 20°, 47° or asymmetrical radiation angle, with power supply. Luminaire and power supply with plug connection. Custom frame measures are available, which makes it ideal to be used as a „renovation downlight“.

Maße / size: L x B / Ø	LED Watt	Lumen	Abstrahlwinkel Beam angle	Art. Nr. item No.	QR-Code Datenblatt / Spec Sheet
142 x 142 mm / 5.6 x 5.6"	18	2.000	11°	1019.40.01.00.12.000.V	
142 x 142 mm / 5.6 x 5.6"	18	2.000	20°	1020.40.01.00.12.000.V	
142 x 142 mm / 5.6 x 5.6"	18	2.000	47°	1021.40.01.00.12.000.V	
142 x 142 mm / 5.6 x 5.6"	18	2.000	asym.	1022.40.01.00.12.000.V	
Ø 145 mm / 5.6"	18	2.000	11°	1513.40.01.00.12.000.V	
Ø 145 mm / 5.6"	18	2.000	20°	1514.40.01.00.12.000.V	
Ø 145 mm / 5.6"	18	2.000	47°	1515.40.01.00.12.000.V	
Ø 145 mm / 5.6"	18	2.000	asym.	1516.40.01.00.12.000.V	

STANDARD

LED 24V | CRI > 97 | neutralweiß / Neutral-white 4000 K

ohne Dimmung / without dimmer

Direkt abstrahlend / direct light output

weiß pulverbeschichtet / white powder coated 12

Montageversion / Mounting version



OPTIONAL

2700 K, 3000 K

DALI, Switch Dim, ready2mains™, CASAMBI, ENOCEAN wireless push button

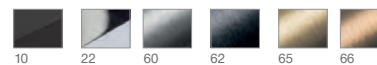

210.00.00.00.00 IP 44 Aufrüstung / upgrade

Blenden Sondermaße sind auf Anfrage möglich.
Custom frame measures on request.



Project: Stadthalle Kassel

BE 3 | Ø 145 mm | Art.Nr. 1513.

BE3 HIGH OUTPUT

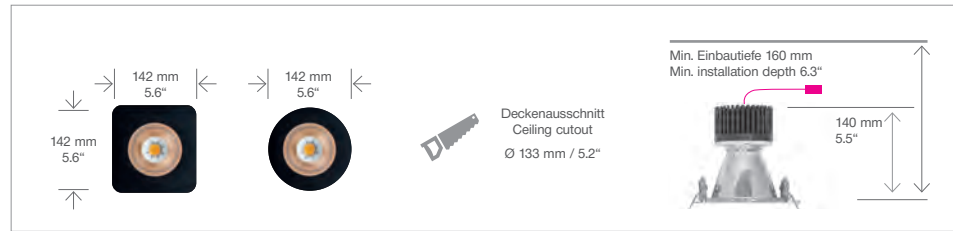

Der Downlight für extrem hohen Lumen-Output. Dabei bleibt er in Form und Farbe optisch dezent, wahlweise quadratisch oder rund mit 11°, 20°, 47° oder asymmetrischen Abstrahlwinkel, inkl. Netzteil. Durch anpassbare Abdeckung auch ideal als Sanierungsdownlight zu verwenden.

The downlight for extremely high lumen output, in an unobtrusive shape and colour, available square and round with radiation angles of 11°, 20°, 47° or asymmetrical radiation angle, with power supply. Luminaire and power supply with plug connection. Custom frame measures are available, which makes it ideal to be used as a „renovation downlight“.

Maße / size: L x B / Ø	LED Watt	Lumen	Abstrahlwinkel Beam angle	Art. Nr. item No.	QR-Code Datenblatt / Spec Sheet
142 x 142 mm / 5.6 x 5.6"	31	3.600	11°	1520.40.01.00.12.000.V	
142 x 142 mm / 5.6 x 5.6"	31	3.600	20°	1521.40.01.00.12.000.V	
142 x 142 mm / 5.6 x 5.6"	31	3.600	47°	1522.40.01.00.12.000.V	
142 x 142 mm / 5.6 x 5.6"	31	3.600	asym.	1523.40.01.00.12.000.V	
Ø 145 mm / 5.6"	31	3.600	11°	1524.40.01.00.12.000.V	
Ø 145 mm / 5.6"	31	3.600	20°	1525.40.01.00.12.000.V	
Ø 145 mm / 5.6"	31	3.600	47°	1526.40.01.00.12.000.V	
Ø 145 mm / 5.6"	31	3.600	asym.	1527.40.01.00.12.000.V	

STANDARD

LED 24V | CRI > 90 | neutralweiß / Neutral-white 4000 K

ohne Dimmung / without dimmer

Direkt abstrahlend / direct light output

weiß pulverbeschichtet / white powder coated 12

Montageversion / Mounting version



OPTIONAL

2700 K, 3000 K

DALI, Switch Dim, ready2mains™, CASAMBI, ENOCEAN wireless push button

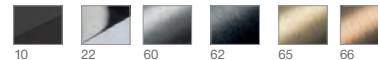

210.00.00.00.00 IP 44 Aufrüstung / upgrade

Blenden Sondermaße sind auf Anfrage möglich.
Custom frame measures on request.

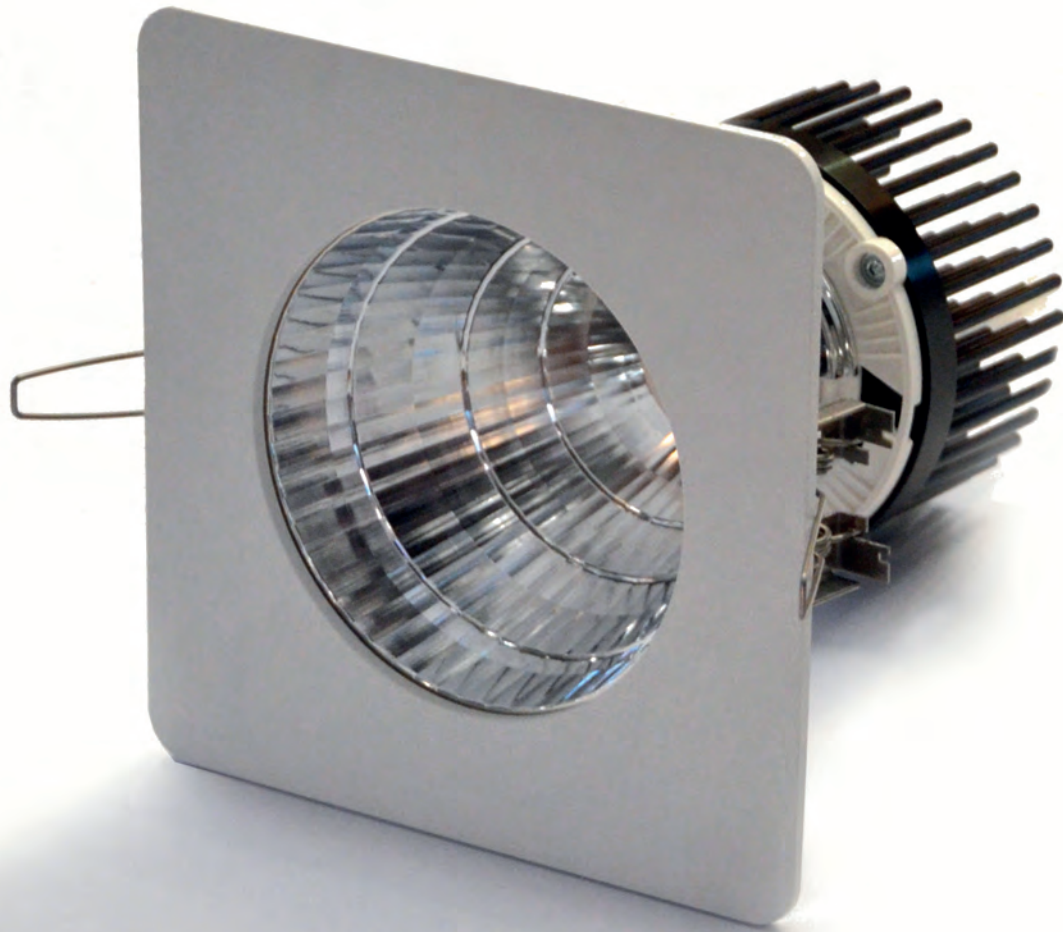

PENDELLEUCHTEN
PENDANT LIGHTS





ROTOLO



Minimalistische LED-Ringleuchte aus pulverbeschichtetem Aluminiumprofil. Als Einzelleuchte oder kombiniert mit verschiedenen Größen

Minimalist LED ring luminaire made of powder coated aluminium profile. Available as a single luminaire or combined in various sizes.

Maße / size: Ø	LED Watt	Lumen	Art. Nr. item No.	QR-Code Datenblatt / Spec Sheet
910 mm / 35.8"	47	3.259	1000.40.51.00.11.Z70.B	
1.250 mm / 49.2"	61	4.227	1001.40.51.00.11.Z70.B	
1.560 mm / 61.4"	80	5.537	1011.40.51.00.11.Z70.B	
1.910 mm / 75.1"	88	6.114	1012.40.51.00.11.Z70.B	

STANDARD

 LED 24V | CRI > 90 | neutralweiß / Neutral-white 4000 K

 Dimmung / dimmable 0 - 10V, 1 - 10V

 Direkt abstrahlend / direct light output

 weiß pulverbeschichtet / white powder coated 11

 Zuleitung silbergrau / power supply cable silver-grey Z70

 Montageversion / Mounting version **B**

OPTIONAL

2700 K, 3000 K

DALI, CASAMBI
ENOCEAN wireless push button

 30

G



BWP
PREMIER
BEST WESTERN

Project: Barocksaal Hotel Villa Stokkum
Architect: outsidelN, Wiesbaden
Photo: Roland Gruen

7 x ROTOLO 1250 mm | Art.Nr. 1001
3 x ROTOLO 1560 mm | Art.Nr. 1011

DUETTO DIRECT | INDIRECT





DUETTO DIRECT

DIRECT HIGH OUTPUT

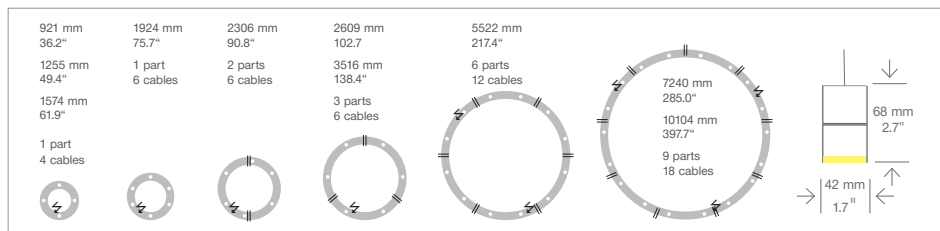







LED-Ringleuchte direkt abstrahlend, aus Aluminium. Ausführung HIGH OUTPUT mit über doppelter Leistung für maximale Ausleuchtung.

LED ring luminaire, direct light output, made of aluminium. HIGH OUTPUT version with more than twice the power for maximum illumination.

Maße / size: Ø	LED Watt		Lumen		Art. Nr. / item No.		QR-Code Datenblatt / Spec Sheet
	Regular	High Output	Regular	High Output	Regular	High Output	
921 mm / 36.2"	48	102	2.367	5.544	1629.	2090. 30.01.00.12.Z70.A	
1.255 mm / 49.4"	67	137	3.552	7.606	1630.	2091. 30.01.00.12.Z70.A	
1.574 mm / 61.9"	85	174	4.567	9.699	1631.	2092. 30.01.00.12.Z70.A	
1.924 mm / 75.7"	105	212	5.638	11.805	1632.	2093. 30.01.00.12.Z70.A	
2.306 mm / 90.8"	126	265	6.442	14.403	1633.	2094. 30.01.00.12.Z70.A	
2.609 mm / 102.7"	144	304	7.472	16.628	1634.	2095. 30.01.00.12.Z70.A	
3.516 mm / 138.4"	195	387	10.070	21.043	1635.	2096. 30.01.00.12.Z70.A	
5.522 mm / 217.4"	308		15.815		1636.	30.01.00.12.Z70.A	
7.240 mm / 285.0"	372		20.735		1637.	30.01.00.12.Z70.A	
10.104 mm / 397.7"	562		28.937		1638.	30.01.00.12.Z70.A	

STANDARD

-  LED 24V | CRI > 90 | warmweiß / warm-white 3000 K
-  Ohne Dimmung / without dimming
-  Direkt abstrahlend / direct light output
-  weiß pulverbeschichtet / white powder coated 12
-  Zuleitung silbergrau / power supply cable silver-grey Z70
-  Montageversion / Mounting version **A**

OPTIONAL

- 2700 K, 4000 K
- 0 - 10V, 1 - 10V, DALI, CASAMBI
ENOCEAN wireless push button



10

- B**
- E**
- S**



DUETTO DIRECT | INDIRECT DIRECT | INDIRECT HIGH OUTPUT

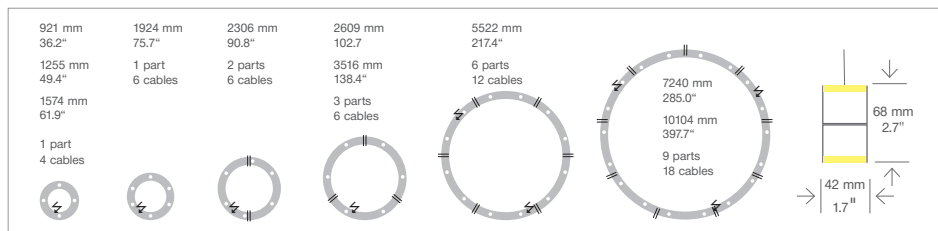

LED-Ringleuchte direkt und indirekt abstrahlend, aus Aluminium. Ausführung HIGH OUTPUT mit über doppelter Leistung bei der direkten Ausleuchtung.

LED ring luminaire, direct and indirect light output, made of aluminium. HIGH OUTPUT version with more than twice the power for direct illumination.

Maße / size: Ø	LED Watt		Lumen		Art. Nr. / item No.		QR-Code Datenblatt / Spec Sheet
	Regular direct indirect	High Output direct indirect	Regular direct indirect	High Output direct indirect	Regular	High Output	
921 mm / 36.2"	48	16	2.367	787	1629.	2090.	30.02.30.12.Z70.A
1.255 mm / 49.4"	67	22	3.552	1.135	1630.	2091.	30.02.30.12.Z70.A
1.574 mm / 61.9"	85	28	4.567	1.430	1631.	2092.	30.02.30.12.Z70.A
1.924 mm / 75.7"	105	35	5.638	1.768	1632.	2093.	30.02.30.12.Z70.A
2.306 mm / 90.8"	126	42	6.442	2.139	1633.	2094.	30.02.30.12.Z70.A
2.609 mm / 102.7"	144	48	7.472	2.387	1634.	2095.	30.02.30.12.Z70.A
3.516 mm / 138.4"	195	65	10.070	3.127	1635.	2096.	30.02.30.12.Z70.A
5.522 mm / 217.4"	308	103	15.815	5.052	1636.		30.02.30.12.Z70.A
7.240 mm / 285.0"	372	137	20.735	6.624	1637.		30.02.30.12.Z70.A
10.104 mm / 397.7"	562	188	28.937	9.244	1638.		30.02.30.12.Z70.A



STANDARD



LED 24V | CRI > 90 | warmweiß / warm-white 3000 K



Ohne Dimmung / without dimming



direkt/indirekt abstrahlend | direct /indirect light output



weiß pulverbeschichtet / white powder coated 12



Zuleitung silbergrau / power supply cable silver-grey Z70



Montageversion / Mounting version **A**

OPTIONAL

2700 K, 4000 K

0 - 10V, 1 - 10V, DALI, CASAMBI
ENOCEAN wireless push button



10

B E S



LA BELLA

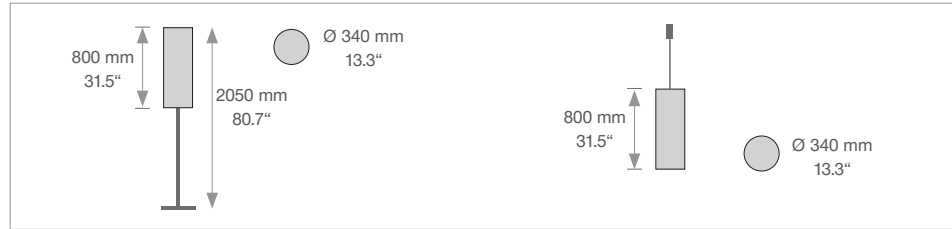

Zeitlose Steh-, oder Pendelleuchte mit creme weißem Stoffschirm,
Timeless floor or pendant luminaire with creamy-white fabric shade.

Maße / size: Ø x L

LED Watt

Lumen

Art. Nr.
item No.

QR-Code
Datenblatt / Spec Sheet

Stehleuchte / Floor light

340 x 2.050 mm / 13.3 x 80.7"

4 x 10 2.500

8 x 10 5.000

312.30.64.00.16.Z91.N

312.30.68.00.16.Z91.N

Pendelleuchte / Pendant light

340 x 800 mm / 13.3 x 31.4"

4 x 10 2.500

8 x 10 5.000

319.30.64.00.12.Z70.E

319.30.68.00.12.Z70.E



STANDARD



LED 24V | CRI > 90 | warmweiß / Warm-white 3000 K



mit Dimmung / with dimmer



Direkt abstrahlend / direct light output



Schirmfarbe in creme weiß / Lampshade cream white

Farbe Stehleuchtenfuß / Finish floor lamp base



silber / silver 16

OPTIONAL

2700 K, 4000 K

DALI (Pendelleuchte, pendant lamp)

Weitere Farben auf Anfrage / other colours on request



19



MONTAGEVERSIONEN | MOUNTING VERSIONS

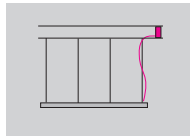

A Seilabhängung mit externer Technikeinheit in Zwischendecke.

Suspension with external power supply unit in suspended ceiling.

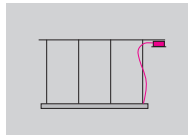

B Seilabhängung mit externer Technikeinheit in Deckenbaldachin.

Suspension with external power supply unit in separate canopy.

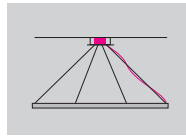

E Abhängung mit Deckenbaldachin.

Suspension through canopy.

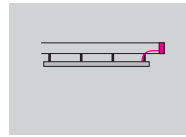

G Decken-Direktbefestigung mit externer Technikeinheit in Zwischendecke.

Direct ceiling mounting with external power supply unit in suspended ceiling.

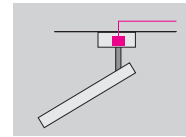

P Decken-, Wandbefestigung, Technikeinheit in Baldachin.

Direct ceiling-, wall mounting with power supply unit in canopy.

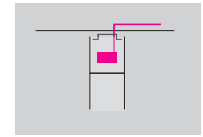

0P Decken-Direktbefestigung, Technikeinheit in Leuchte.

Direct ceiling-, mounting with power supply unit in luminaire.

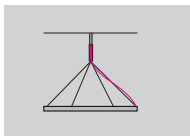

S Abhängung mit Pendelbaldachin.

Suspension with pendant canopy.

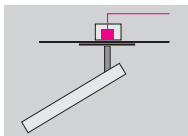

U Deckeneinbau, Technikeinheit in Deckeneinbaudose.

Suspension with cavity ceiling box, power supply external in 4" octagonal junction box.

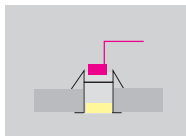

V Deckeneinbau mit Rand in GK-Decke. Technikeinheit in Leuchte.

Ceiling installation with edge in plasterboard ceiling. Operating unit in/ on luminaire.

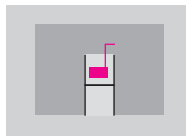

VA Deckeneinbau ohne Rand in Betondecke. Technikeinheit in Leuchte.

Ceiling installation without edge in concrete ceiling. Operating unit in luminaire.

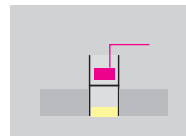

VB Deckeneinbau ohne Rand in GK-Decke. Technikeinheit in Leuchte.

Ceiling installation without edge in plasterboard ceiling. Operating unit in luminaire.

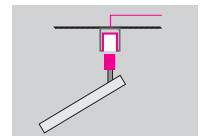

Z Montage mit Stromschienenadapter für PALADIO TRACK System

Installation with adapter for PALADIO TRACK system (48 V).

OBERFLÄCHEN | FINISH

Eloxiert, gebürstet / Anodised, brushed

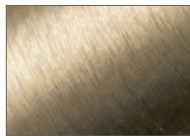

65 Champagner-Gold
champagne gold

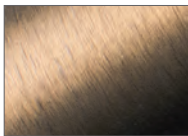

66 Bronze
bronze



62 Schwarz
black

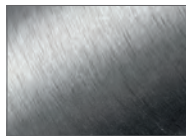

60 Silber
silver



22 handpoliert
hand polished



21 Alu natur
alu nature

Pulverbeschichtet / Powder coated

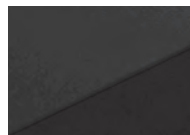

10 Schwarz Feinstruktur
black fine textured



30 Anthrazit Feinstruktur
anthracite fine textured



11 Weiß RAL 9010
Feinstruktur
white RAL 9010
fine textured



12 Weiß RAL 9003
Feinstruktur matt
white RAL 9003
fine textured matt

TECHNISCHE INFORMATIONEN | TECHNICAL INFORMATION



Positive Ökobilanz:

Unsere Leuchten sind mit LED-Technologie der neuesten Generation ausgestattet, sind energiesparend, langlebig, sparen CO₂ und schonen damit Umwelt und Klima. Die Verwendung ausgesuchter Materialien sichert, dass nahezu alle Leuchtenbauteile umweltfreundlich recycelt werden können.

Environmentally Conscious:

Our lights are equipped with the latest in LED technology, which is energy saving and long-lasting, therefore preserving the environment. The use of well selected materials guarantees an environmentally friendly recycling process of almost every component.



A ++

B +

C

D

E

F

G

} LED

Diese Leuchten enthalten eingebaute LED-Lampen:
These lamps have built-in LED lights:

PALADIO PRISM 35 / 54
PALADIO LENS 35 / 54
PALADIO TRACK 35
PALADIO CONNECT 35 / 54
PALADIO DOWNLIGHT
PALADIO WALL
COVE LIGHTING
BE 1
BE 2
BE 3
BE 3 HIGH OUTPUT
EVOLUTION SPOT
EVOLUTION CEILING
ROTOLO
DUETTO
DUETTO HIGH OUTPUT
LA BELLA

874-2012



Erfüllt die Anforderungen aller für dieses Produkt gültigen EG-Richtlinien.
Meets the requirements of all applicable to this product EC directives.



Für diese Produkte können Lichtverteilungskurven angefordert werden.
For this product light distribution curves may be requested.



Deutsche Wertarbeit, Zertifizierte Qualität.
Handcrafted in Germany, certified quality.



Schutzart
Protective rating



Lichtverteilung
Light distribution



Gewicht beachten, ausreichende Deckenbelastbarkeit sicherstellen
Sufficient load capacity of the ceiling structure has to be ensured



Zur Montage auf entflammaren Baustoffen, deren Entzündungstemperatur mindestens 200° C beträgt, geeignet.
Luminaires are suitable for mounting on ordinary flammable materials, which have an inflammation point of at least 200° C.



Schutzklasse
Protection class



Dimmung
Dimmable



LED-Lichttechnik: 2700K, 3000K, 4000K
LED-technology: 2700K, 3000K, 4000K



ENOCEAN
Funkfernbedienung mit Taster
wireless push button



Bluetooth 4.0 CASAMBI
Steuerung mit App
remote control through app

Technische Änderungen, Irrtümer und Druckfehler vorbehalten

1) Tatsächlicher Lumenwert: Verluste durch Diffusoren und Reflektoren sind berücksichtigt. Die Lumen-Werte beziehen sich auf eine Umgebungstemperatur von max. 30°C / 95°F. 2) Leuchtengewichte ohne separate Technischeinheit oder Baldachin.

Technical data is subject to change. Errors and omissions excepted 1) Net lumen output: Losses due to diffusers and reflectors are considered. Lumen values refer to an ambient temperature of max. 35°C / 95°F. 2) Weight of lights without remote technical unit or canopy.

WEITERE LEUCHTEN AUS UNSEREM PORTFOLIO...

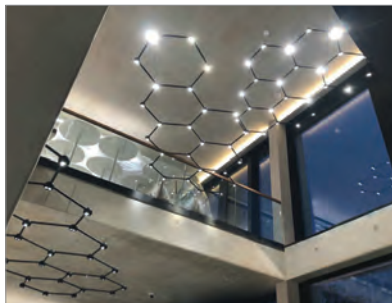

FAVO LIGHT NET



AVVENI PENDANT 8, AVVENI FLOOR 3, AVVENI TABLE



EVOLUTION S



AVVENI SINGLE



PALITO



ANELLO



GIRATA VERTICAL

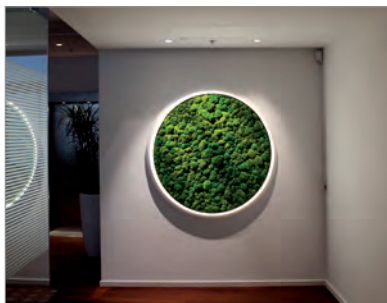

LUCE VERDE SLIM



DOPPIO ELLIPSE

FURTHER LUMINAIRES FROM OUR PORTFOLIO...



AVENI PENDANT 8



CIRCOLO

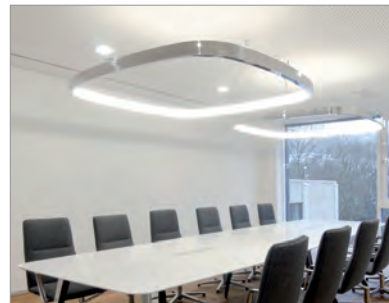

SOFT SQUARE



SOFT DELTA | LIGHT + ACOUSTIC



FINO FLOOR



PALITO MIKADO



GIOCO Combination DIRECT + INDIRECT





TOCCATA



FAVO | THE LIGHT CELL

#sattlerlighting

 @sattlerlighting

 /company/sattlerlighting

 /companies/sattlerlighting

 /sattlerlighting

 .sattler-lighting.com

SATTLER GmbH

Wilhelm-Zwick-Str. 6
73035 Göppingen - Germany

Phone: +49 (0) 7161 / 920 193 - 0

E-Mail: info@sattler-lighting.com

Export Department:

Phone: +49 (0) 7161 / 920 193 - 50

eMail: export@sattler-lighting.com

www.sattler-lighting.com

SATTLER