

AVVENI

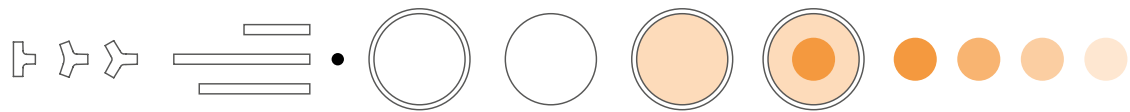
SATTLER



AVVENI



THE STORY	7
FORM AND COLOUR	13
FLEXIBILITY	19
TECHNOLOGY	24
SNAP SYSTEM	35
CONTROLS	40
PORTFOLIO	45
AVVENI TABLE	52
AVVENI FLOOR	56
AVVENI CONCRETE	58
AVVENI PENDANT	64
AVVENI VERTICAL	80
AVVENI CEILING	82
AVVENI SINGLE	90
AVVENI PURE CEILING/WALL	92
AVVENI BRAZO	94
AVVENI DOWNLIGHT	96
AVVENI PURE DOWNLIGHT	100
AVVENI LIGHTLIGHT®	102
AVVENI 3-PHASE-TRACK	106
AVVENI PROJECT	108
TECHNICAL INFORMATION	121



## THE STORY

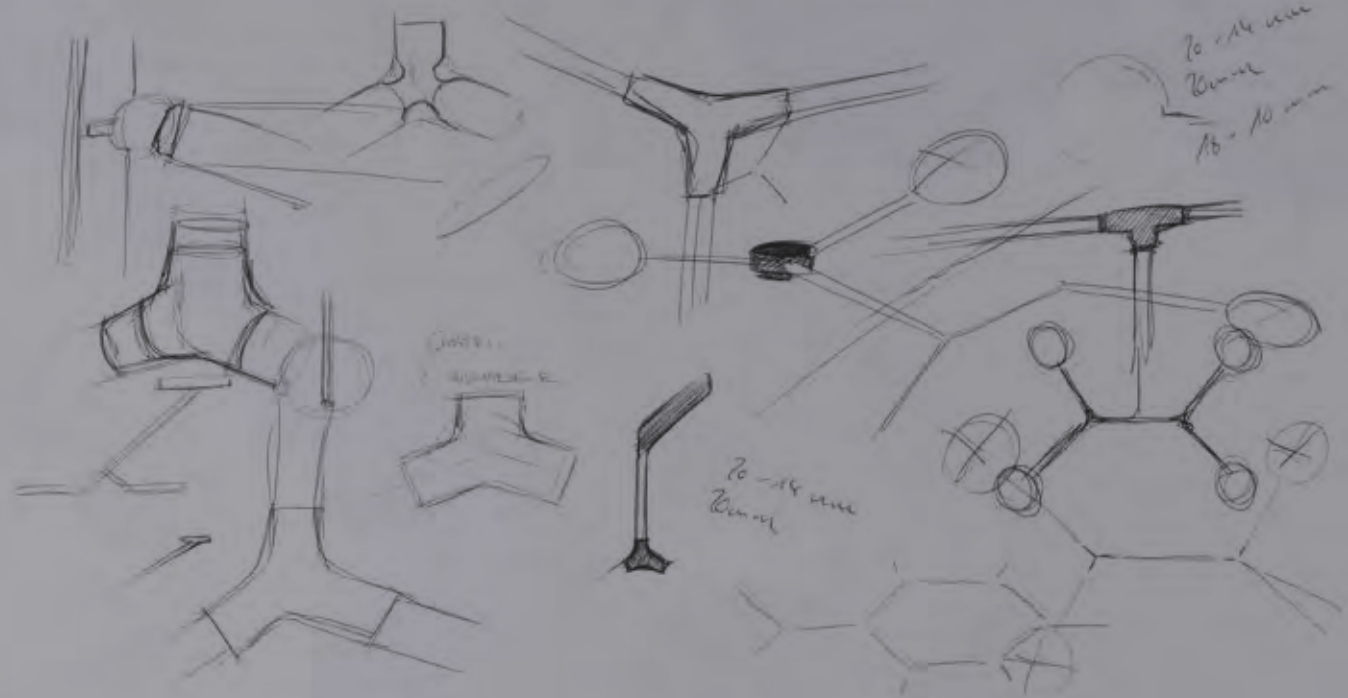
Prägenden Stilelemente des SATTLER Produktportfolios sind minimalistische, großdimensionierte Kreiselemente und deren Variationen. Als kreativer Kopf lässt sich Ulrich Sattler von vielfältigen Formen und Technologien inspirieren. Sei es die Affinität zu italienischen Automobil-Designern und deren markanter Linienführung, oder aber die intensive Wahrnehmung von Elementen seiner täglichen Umgebung aus Natur und Technik. So ist ein Kernstück der AVVENI, der magnetische Kugelverbinder, dem menschlichen Schultergelenk nachempfunden. Hinzu kommt die einer Zellstruktur gleichende Modularität, vom Einzeller bis zur komplexen Struktur. Minimalistic and largely-dimensioned circular shapes, and variations thereof, are distinctive stylistic elements in the SATTLER product portfolio. Ulrich Sattler possesses a highly creative mind and derives his inspiration from different shapes and technologies. This is due to his affinity to Italian automobile design icons and their elegant use of lines as well as his deep appreciation for elements in his everyday environment – both natural and technological. One of AVVENI's main features is its magnetic ball joint modeled after the human shoulder. Moreover, AVVENI has a cell-like modular structure, ranging from a single cell up to a complex structure.



Prägende Stilelemente des SATTLER Produktportfolios sind minimalistische, großdimensionierte Kreiselemente und deren Variationen. Als kreativer Kopf lässt sich Ulrich Sattler von vielfältigen Formen und Technologien inspirieren. Sei es die Affinität zu italienischen Automobil-Designikonen und deren markanter Linienführung, oder aber die intensive Wahrnehmung von Elementen seiner täglichen Umgebung aus Natur und Technik. So ist ein Kernstück der AVVENI, der magnetische Kugelverbinder, dem menschlichen Schultergelenk nachempfunden. Hinzu kommt die einer Zellstruktur gleichenden Modularität, vom Einzeller bis zur komplexen Struktur.

Minimalistic circular shapes in large dimensions, and variations thereof, are distinctive stylistic elements for the SATTLER product portfolio. Ulrich Sattler possesses a highly creative mind and derives his inspiration from different shapes and technologies. These may be inspired by Italian automobile design icons and their elegant use of lines as well as his deep appreciation for elements in his everyday environment – both natural and technological. One of AVVENI's main features is its magnetic ball joint modeled after the human shoulder. Moreover, AVVENI has a cell-like modular structure, ranging from a single cell up to a complex structure.







# ULRICH SATTLER MICHAEL SCHMIDT

Mit Ulrich Sattler und Michael Schmidt haben sich zwei kreative Köpfe gefunden, um die Vision AVVENI in ein zukunftsweisendes Lichtkonzept umzusetzen. Ulrich Sattler ist immer auf der Suche nach neuen Wegen, um diese in klare Formen umzusetzen. Der zweite Kreative, Michael Schmidt, Inhaber des Stuttgarter Designstudios code2design, arbeitet als Industrie- und Produktdesigner international für namhafte Marken. Er versteht sich als Designautor, der Geschichten in Produkte umsetzt.

Ulrich Sattler and Michael Schmidt are two creative minds, which combined, are turning the vision of AVVENI into a trendsetting lighting concept. Ulrich Sattler is constantly striving to find new ways of creating elegant and classic shapes. The second creative mind involved is Michael Schmidt, who is the owner of the code2design studio based in Stuttgart (Germany). He works internationally as a product and industrial designer for several renowned brands and regards himself as a design author - translating stories into products.



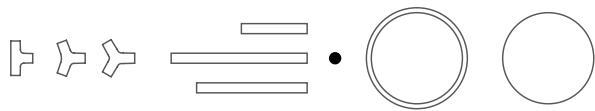
Focus Open 2016  
Gold



GERMAN  
DESIGN  
AWARD  
WINNER  
2017



Für herausragendes Design und Funktionalität wurden Leuchten der AVVENI-Serie bereits mehrfach ausgezeichnet. For outstanding design and functionality, luminaires of the AVVENI series have already won several awards.



# FORM AND COLOUR





Ob Steh-, Pendel- oder Deckenleuchte, die Struktur der AVVENI Leuchtenserie wird geprägt durch Modularität und klare Formensprache. Feine Rundungen und Übergänge, aufeinander abgestimmte Radien und Winkелеlemente ergeben in jeder Kombination ein stimmiges Gesamtbild.

The AVVENI luminaire series is characterised by its unique modular structure and clear expression of form which can be applied to floor lights, pendant or ceiling luminaires. Delicate curvatures and transitions as well as synchronised radiuses and angle elements result in a harmonious form in any combination.

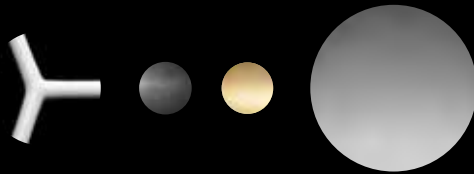
LOOK AND FEEL

# COLOUR

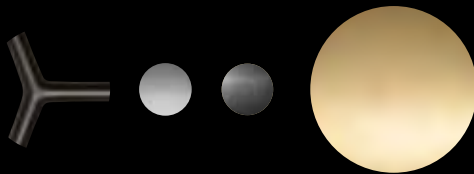
Die spannende Kombination von reduzierter Formensprache, edler Haptik der Oberflächen und variabler Farbgebung ergeben eine hohe Flexibilität bei der Anpassung an die jeweilige Raumarchitektur. Neben der gewählten Farbe der Leuchte, bestehend aus Struktur und Ring des Leuchtenkopfes, poliert, schwarz oder weiß lackiert, kann die Deckelfarbe des Leuchtenkopfes individuell gewählt werden: Mit feinem Schliff, in Gold, Schwarz und Silber ergeben sich so elegante Kombinationsmöglichkeiten.

The intriguingly reduced expression of form, a classy surface feel and variable colour schemes enable a high degree of flexibility for the adaption to any particular room architecture. The AVVENI consists of the main modular structure including the light head ring, which comes polished or anodised in black or white. The light head top cover is available in anodised gold, black or silver. All these colour options can be individually selected and allow for exquisite variations.

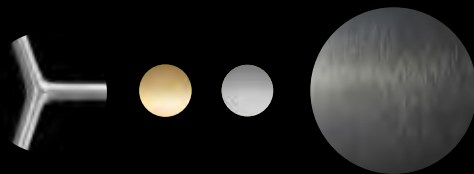




Strukturfarbe: weiß RAL 9003  
 Deckelfarbe: schwarz, gold, silber (eloxiert)  
 Finish structure: white RAL 9003  
 Finish top cover: black, gold, silver (anodised)

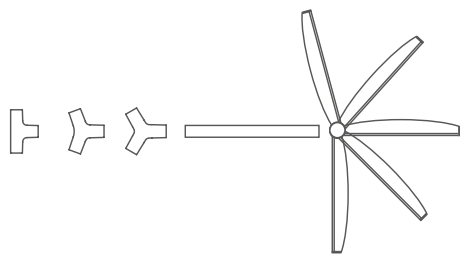


Strukturfarbe: schwarz matt  
 Deckelfarbe: silber, schwarz, gold (eloxiert)  
 Finish structure: black matt  
 Finish top cover: silver, black, gold (anodised)



Strukturfarbe: Aluminium poliert  
 Deckelfarbe: gold, silber, schwarz (eloxiert)  
 Finish structure: aluminium polished  
 Finish top cover: gold, silver, black (anodised)





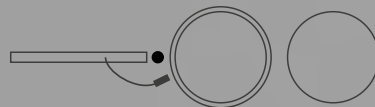
FLEXIBILITY



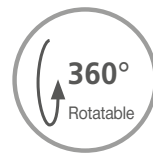
# CONNECTION

Zentrales Verbindungselement mit einem Höchstmaß an Bewegungsfreiheit ist der magnetische Kugelgelenkverbinder. Zwischen Leuchtenstruktur und dem auswechselbaren Kopf der Leuchte ist er dem menschlichen Schultergelenk nachempfunden und sorgt in jeder Position für stabilen Halt.

A magnetic joint modeled on the human shoulder enables the highest flexibility of movement possible and acts as the central connecting element between the luminaire structure and its exchangeable light head, thus providing stability in any position.







Beweglichkeit ohne Einschränkung, dreh- und schwenkbar. Der kugelgelagerte Leuchtenkopf der AVVENI-Serie macht alle Bewegungen mit. Dabei garantiert das magnetische Verbindungselement festen Halt. Einfach am Leuchtenring ausstecken, lässt sich der Leuchtenkopf durch Abnehmen vom Magneten jederzeit austauschen. Durch die Kombination von unterschiedlichen Leuchtenköpfen lassen sich so kreative Lichtlösungen realisieren.

180°+360°

Movement without limits, whether horizontal, vertical or rotatory – the light head of the AVVENI series does it all. A magnetic connecting element provides guaranteed stability. The light head can be easily popped in and out at any time by simply taking off the magnet and disconnecting the cable connection. The combined use of different light heads enables the creation of a multitude of lighting solutions.



Unsichtbar im Kopf der AVVENI verborgen, garantiert die Technologie der Leuchte ein Höchstmaß an Flexibilität, Effizienz und Nachhaltigkeit. Modernste Vollspektrum LED-Technologie mit einem Farbwiedergabewert von > 95 ist besonders energiesparend und bildet Farbabstufungen sowie Kontraste hervorragend ab. Darüber hinaus ermöglicht die integrierte Dimmung das separate Ansteuern jedes einzelnen Leuchtenkopfes. Beim Spot-Leuchtenkopf der AVVENI kann Flächen- und Spotlicht unabhängig voneinander geschaltet und individuell gedimmt werden.

## TECHNOLOGY

Elegantly hidden in the AVVENI light head is the technology of the fixtures. It guarantees the highest degree of flexibility, efficiency and sustainability. State-of-the-art full spectrum LED technology with a colour rendering index of > 95 is exceptionally energy-saving. Colour gradation and contrasts are magnificently displayed. Moreover, the integrated dimmer makes it possible to control each individual light head separately. The AVVENI spot light head even enables independent switching between the spot and background light as well as individual dimming.







Energieeffiziente Vollspektrum-LED-Technologie.  
Energy-efficient full spectrum LED technology.



LED-Technologie mit einem Farbwiedergabewert von >95 für höchsten Sehkomfort bei Farbe und Kontrast.

LED technology with a colour rendering index of >95 for the highest degree of optical convenience regarding colour and contrast.



Mit dem SNAP-SYSTEM lässt sich der 9° Abstrahlwinkel des Spots auch nachträglich auf 17°, 25°, 36° und 60° erweitern.

The convenient SNAP SYSTEM makes it possible to subsequently change the beam angle of 9° to 17°, 25°, 36° or 60°.



Dimmung wahlweise 0-10V, 1-10V, DALI oder Bluetooth Steuerung.

Optional dimming 0-10V, 1-10V, DALI or Bluetooth control.



Folgende Standardlichtfarben stehen zur Auswahl: extra warmweiß 2700K, warmweiß 3000K und neutralweiß 4000K.

The following light colours are available: extra warm-white 2700K, warm-white 3000K and neutral-white 4000K.





# HEAD

Die Leuchten des AVVENI-Systems können mit zwei unterschiedlichen Leuchtenköpfen bestückt werden. FLOOD- und SPOT-Leuchtenköpfe können auch nachträglich jederzeit gewechselt werden. Zudem ist auch der Einsatz von unterschiedlichen Leuchtentypen in einer Struktur möglich.

The luminaires in the AVVENI series can be fitted with two different light heads. FLOOD and SPOT light heads may be exchanged at any time. Moreover, different light heads can be fitted on any structure.







# FLOOD

Leuchtenkopf mit FLOOD Abstrahlung und zirkularer Prismenscheibe für eine weiche, homogene Lichtabstrahlung. Wahlweise in den Lichtfarben 2700K, 3000K und 4000K und 17W LED Leistung.

Light head with FLOOD light distribution and a circular prism diffuser for a soft and homogenous light beam. Available in the light temperatures 2700K, 3000K and 4000K and 17W LED power.



2700 KELVIN

3000 KELVIN

4000 KELVIN



## SPOT 9-60°

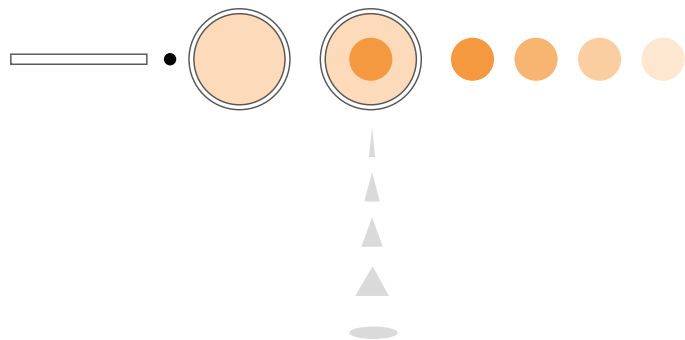
Leuchtenkopf mit SPOT Abstrahlung für effektvol-  
les Akzentlicht und umlaufendes Flächenlicht. Der  
Abstrahlwinkel von 9° kann nachträglich mittels des  
magnetischen SNAP-SYSTEMS jederzeit angepasst  
werden. Spot 15,5W, Flächenlicht 3,5W.

Light head with SPOT light beam for accentuated light  
and surrounding background flood light distribution.  
The beam angle of 9° can be easily adjusted through  
the SNAP SYSTEM. Spot light 15,5W, flood light 3,5W.





9° 17° 25° 36° 60°



# SNAP SYSTEM

# INDIVIDUAL

AVVENI Leuchten mit 9° Spot bieten durch das integrierte SNAP-SYSTEM verschiedene Möglichkeiten, sich nachträglich dem jeweiligen Bedarf anzupassen. So können Abstrahlwinkel und -form, sowie die Farbtemperatur mittels magnetischer Filterscheiben geändert und bis zu drei Filter miteinander kombiniert werden.

AVVENI luminaires with 9° spot offer various ways of adaption to any customer's requirements by use of the integrated SNAP SYSTEM. Beam angle and shape as well as the colour temperature may be changed using magnetic snap-on lenses. Up to three lenses can be combined.



Spot-light lenses



Light colour lenses



Elliptical lenses






Anti glare protection







### BEAM ANGLE LENSES

Spot-light lenses:  9° Standard  17°  25°  36°  60°  13° Asymmetrical

Elliptical lenses:  10-36°  10-60° Squarish lens:  36-36°

### LIGHT COLOUR LENSES

STANDARD	2700 K 	3000 K 	4000 K 
CTO 1/4	2450 K 	2700 K 	3500 K 
CTO 1/2	2200 K 	2400 K 	3000 K 
CTO 3/4	2000 K 	2200 K 	2700 K 

### ANTI GLARE PROTECTION





# COMPOSITION

AVVENI verleiht Ihrer Kreativität ungeahnte Möglichkeiten, lassen Sie Ihren Ideen freien Lauf. Komponieren Sie eigene, stilvolle Lichtszenarien voller Spannung und Dynamik, mit ausgesuchten technischen Zutaten modernster Lichttechnik.

AVVENI allows for unimaginable creative potential – let your ideas flow freely. Compose your own stylistic light concepts in an exciting and dynamic way, including selected components and state-of-the-art light technology.





# CONTROL

Bei AVVENI Leuchten mit mehreren Leuchtenköpfen und Anwendungen mit unterschiedlichem Lichtbedarf ist die Steuerung durch 0-10V, 1-10V, DALI oder die CASAMBI Smartphoneapplikation möglich. Mittels Smartphone kann jeder Leuchtenkopf einzeln angesteuert werden. Zudem kann beim SPOT-Kopf der Spot und das Flächenlicht unabhängig voneinander gedimmt und geschaltet werden.

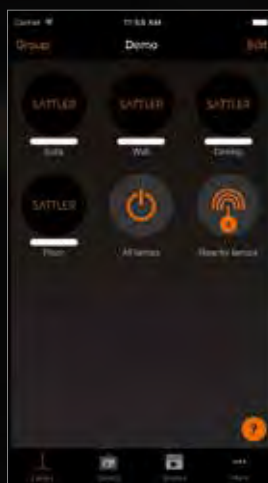
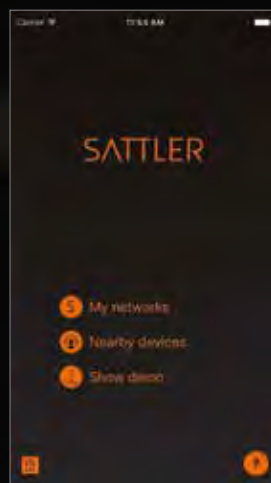
AVVENI luminaires, with several light heads and varying needs of application may be controlled with 0-10V, 1-10V, DALI or the CASAMBI smartphone application. Using CASAMBI each individual light head can be controlled separately. Moreover, the SPOT head enables the independent control of the spot and the surrounding background light as well as individual dimming.

0-10V | 1-10V | DALI | CASAMBI



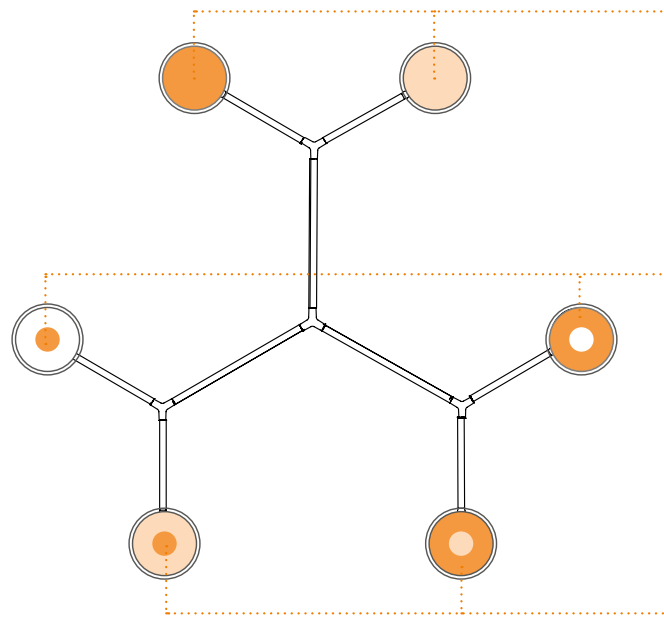


SATTLER Smartphone  
Application with CASAMBI  
Bluetooth





# AVVENI LIGHT CONTROL



## **FLOOD**

Jeder Leuchtenkopf separat dimm- und schaltbar.

Each light head can be dimmed and controlled individually.

## **SPOT**

Spot und Flächenlicht separat schaltbar.

Spot and background light can be controlled separately.

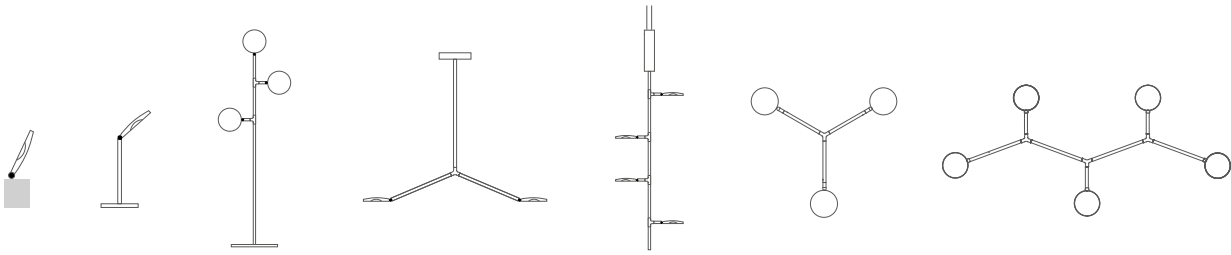
## **SPOT**

Spot und Flächenlicht separat dimmbar.

Spot and background light can be dimmed separately.

Jeder Leuchtenkopf verfügt über eine integrierte Intelligenz und kann über die CASAMBI Smartphoneapplikation mit Bluetooth individuell angesteuert werden.

Each light head contains a smart user interface which can be controlled individually via the CASAMBI smartphone application with Bluetooth.

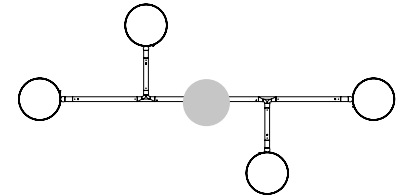
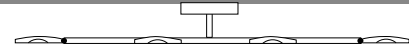




## AVVENI CEILING 4

1744 x 882 mm  
68.6 x 34.7"

No. 1154...



## AVVENI SINGLE

Deckenanbau  
Surface mounted  
No. 1112...

## AVVENI 3-PHASE-TRACK

Stromschienen Adapter  
Live track adapter  
No. 1113...

## AVVENI LIGHTLIGHT®

Stromschienensystem  
Track system  
No. 1153...

## AVVENI SINGLE

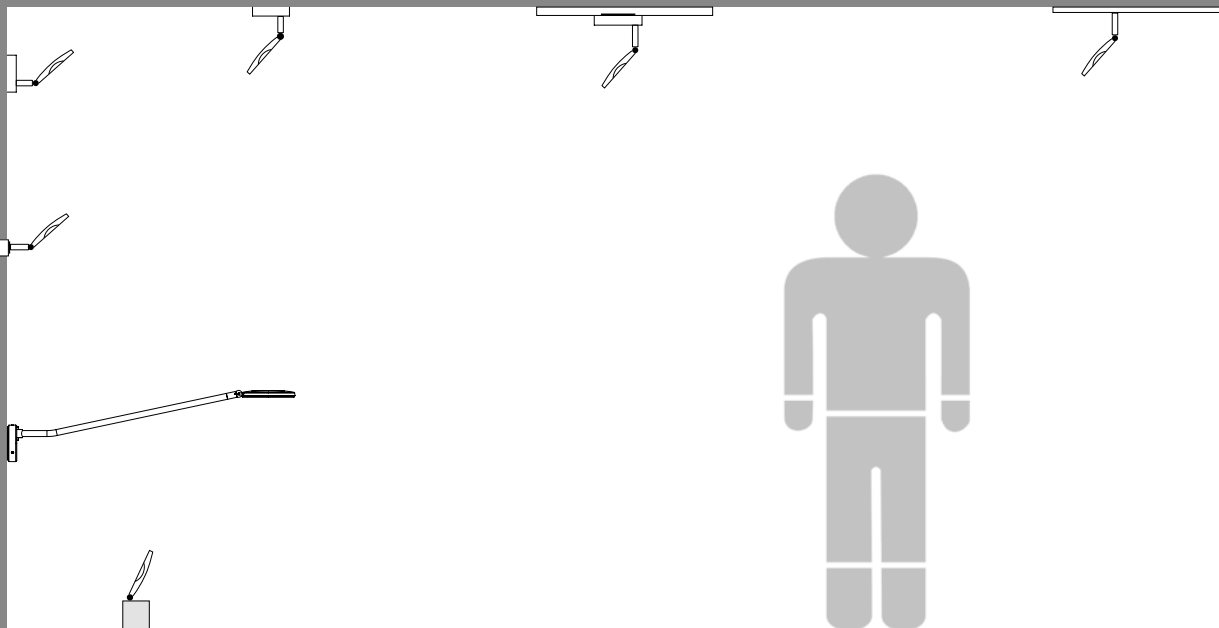
Wandanbau /  
Surface mounted  
No. 1112...

## AVVENI PURE WALL

Wandebau /  
Recessed  
No. 1111...

## AVVENI BRAZO

No. 1212...



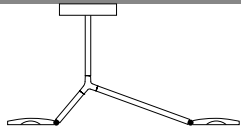
## AVVENI CONCRETE

315 mm  
12.4"  
No. 1155...

## AVVENI CEILING<sup>2</sup>

asymmetrical  
410 x 1007 mm  
16.1 x 39.6"

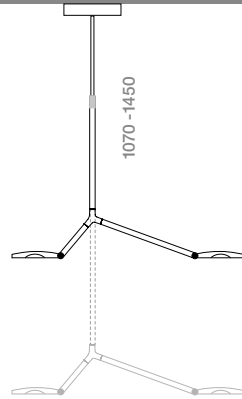
No. 1121...



## AVVENI CEILING<sup>2</sup>

asymmetrical  
1070 - 1450 x 1007 mm  
42.1 - 57.0 x 39.6"

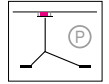
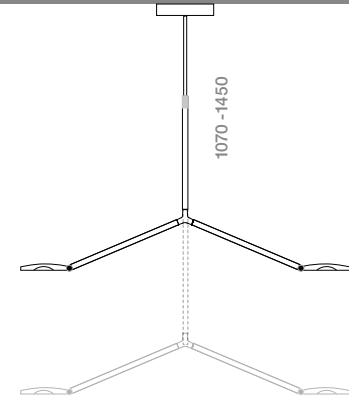
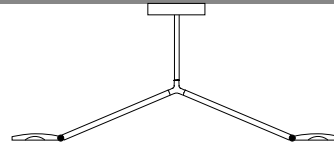
No. 1122...



## AVVENI CEILING<sup>2</sup>

symmetrical  
410 x 1332 mm  
16.1 x 52.4"

No. 1117...



## AVVENI PURE CEILING

Deckeneinbau  
Recessed

No. 1114...



## AVVENI PURE DOWNLIGHT

Deckeneinbau  
Recessed

No. 1157...



## AVVENI DOWNLIGHT

Deckeneinbau  
Recessed

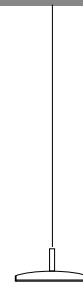
No. 1115... / 1116...



## AVVENI PENDANT<sup>1</sup>

Ø 196 x 101 mm  
Ø 7,7 x 3,9"

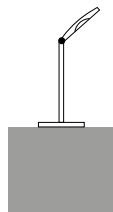
No. 1211...



## AVVENI TABLE

560 mm  
22.0"

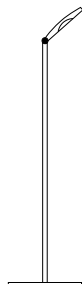
No. 1100...



## AVVENI FLOOR

1260 mm  
49.6"

No. 1105...



## AVVENI FLOOR

1760 mm  
69.3"

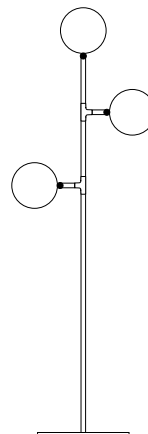
No. 1106...

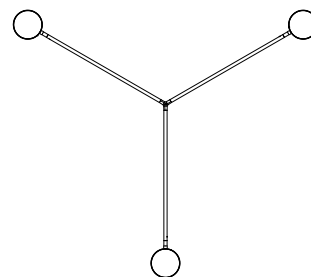
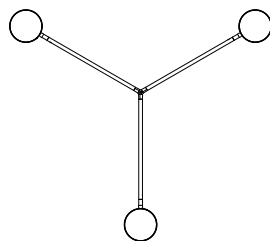
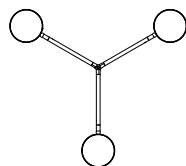
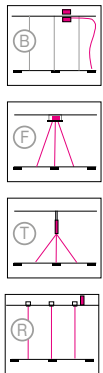


## AVVENI FLOOR<sup>3</sup>

1822 mm  
71.7"

No. 1110...





### AVVENI PENDANT <sup>3</sup>

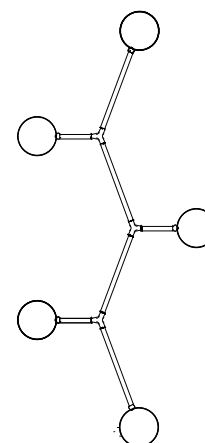
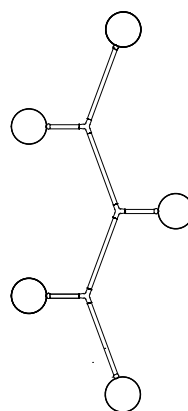
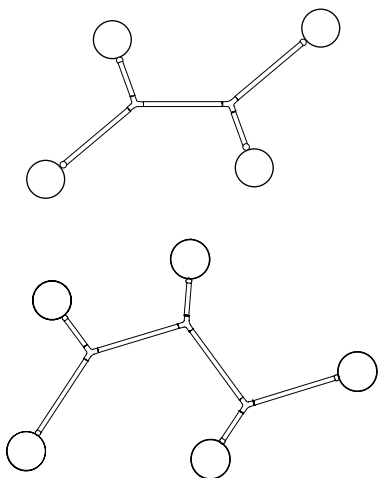
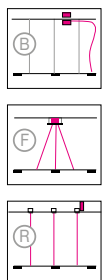
1052 x 936 mm  
41.4 x 36.9"  
No. 1125...

### AVVENI PENDANT <sup>3</sup>

1570 x 1386 mm  
61.8 x 54.6"  
No. 1126...

### AVVENI PENDANT <sup>3</sup>

2055 x 1806 mm  
80.9 x 71.1"  
No. 1127...



### AVVENI PENDANT <sup>4</sup>

1581 x 957 mm  
62.2 x 37.6"  
No. 1210...

### AVVENI PENDANT <sup>5</sup>

1959 x 1372 mm  
77.1 x 54.0"  
No. 1130...

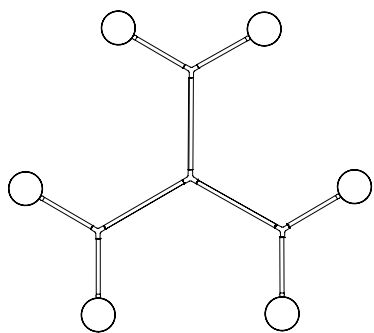
### AVVENI PENDANT <sup>5</sup>

2208x 1043 mm  
86.2x 41.1"  
No. 1128...

### AVVENI PENDANT <sup>5</sup>

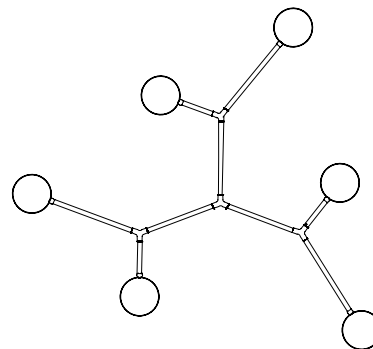
2960 x 1111mm  
116.5 x 43.8"  
No. 1129...





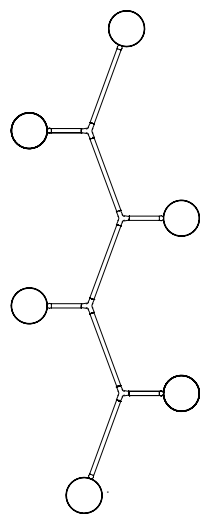
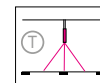
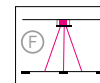
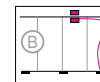
### AVVENI PENDANT 6

1625 x 1434 mm  
64.0 x 56.4"  
No. 1136...



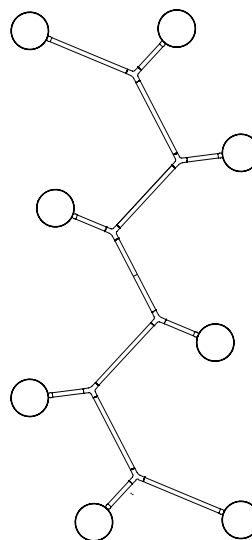
### AVVENI PENDANT 6

1948 x 1800 mm  
76.7 x 71.0"  
No. 1137...



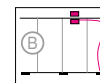
### AVVENI PENDANT 6

2658 x 1043 mm  
104.6 x 41.1"  
No. 1135...



### AVVENI PENDANT 8

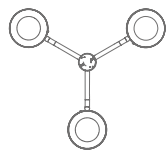
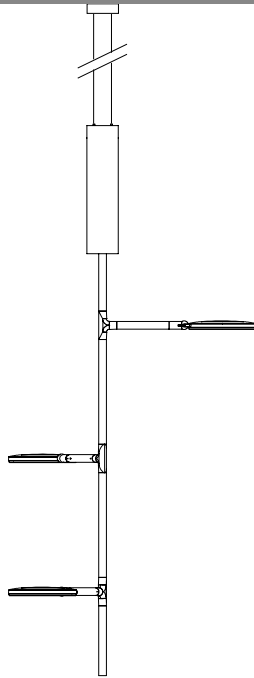
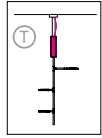
2679 x 1301 mm  
105.5 x 51.2"  
No. 1140...



### AVVENI VERTICAL <sup>3</sup>

1574 x 881 mm  
61.9 x 34.7"

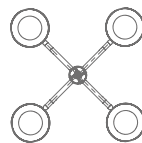
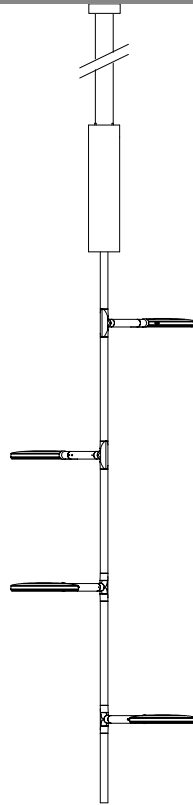
No. 1150...



### AVVENI VERTICAL <sup>4</sup>

1955 x 881 mm  
76.9 x 34.7"

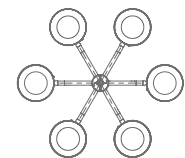
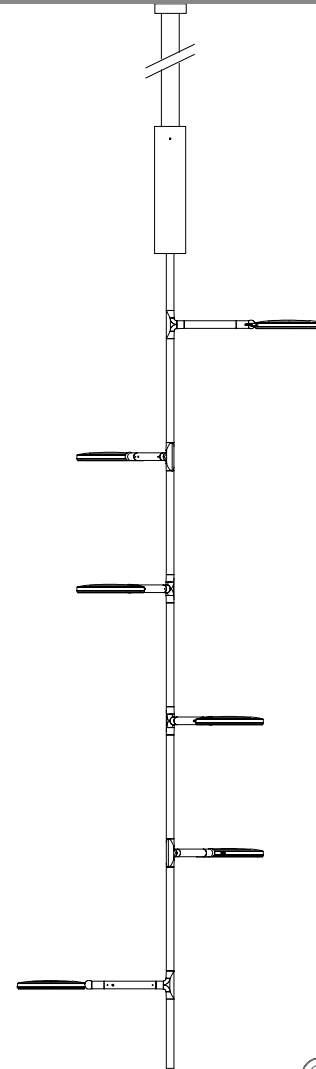
No. 1151...



### AVVENI VERTICAL <sup>6</sup>

2717 x 881 mm  
106.9 x 34.7"

No. 1152...





AVVENI TABLE | FLOOR | CONCRETE



AVVENI TABLE



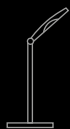


AVVENI FLOOR<sup>3</sup>

AVVENI CONCRETE



AVVENI TABLE

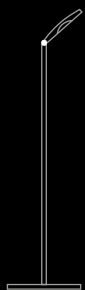


H 560 / Ø 200 mm  
H 22.0 / Ø 7.9"  
No. 1100...

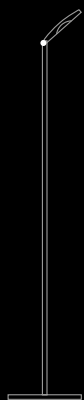


Photo: Gergo Gosztom / Gosztom foto

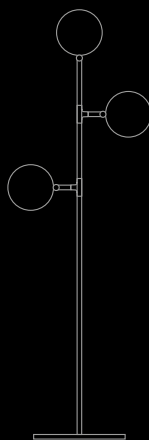
## AVVENI FLOOR



FLOOR  
1260 mm  
49.6"  
No. 1105...



FLOOR  
1760 mm  
69.3"  
No. 1106...



FLOOR<sup>3</sup>  
1822 mm  
71.7"  
No. 1110...





# AVVENI CONCRETE



CONCRETE - die AVVENI Betonleuchte. Flexibel im Raum positioniert zeigt sie einen völlig neuen Leuchtenansatz. Individuell angesteuert über die CASAMBI Smartphoneapplikation setzt sie kreative Akzente.

CONCRETE - the AVVENI concrete light - represents an entirely new approach to lighting due to its ability to be flexibly positioned in a room. It can be controlled individually via CASAMBI smartphone application, thus enabling a uniquely creative touch.



AVVENI  
CONCRETE



H 315 / Ø 88 mm  
H 12.4 / Ø 3.5"  
No. 1155...







AVVENI CONCRETE





Haus Zochental - Liebel Architekten, Aalen

AVVENI CEILING 2

AVVENI FLOOR 3





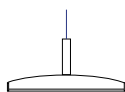
2 x SLIM

7 x AVVENI DOWNLIGHT

AVVENI PENDANT 5

# AVVENI PENDANT

AVVENI PENDANT <sup>1</sup>



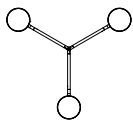
Ø 196 x H 24 mm  
Ø 7.7 x H 0.9"  
No.1211...







### AVVENI PENDANT <sup>3</sup>



1052 x 936 mm  
41.4 x 36.9"  
No.1125...

1570 x 1386 mm  
61.8 x 54.6"  
No. 1126...

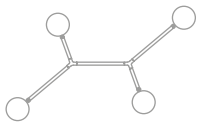
2055 x 1806 mm  
80.9 x 71.1"  
No. 1127...







AVVENI PENDANT <sup>4</sup>



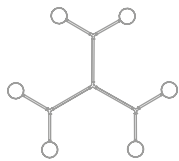
1581 x 957 mm  
62.2 x 37.6"  
No.1210...







AVVENI PENDANT <sup>6</sup>



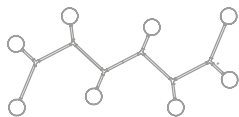
1625 x 1434 mm  
64.0 x 56.4"  
No. 1136...





Photo: Burg + Schuh

AVVENI PENDANT <sup>8</sup>



2679 x 1301 mm  
105.5 x 51.2"  
No. 1140...







AVVENI FLOOR 3

AVVENI TABLE

2 x AVVENI PENDANT <sup>8</sup>



2679 x 1301 mm  
105.5 x 51.2"  
No. 1140...







AVVENI PENDANT <sup>8</sup>



2679 x 1301 mm  
105.5 x 51.2"  
No. 1140...



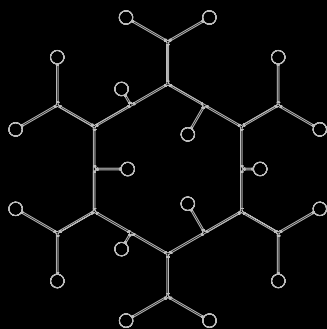
Praxis Dr. Bernas, Eislingen



AVVENI PENDANT 8

AVVENI Downlight

AVVENI PENDANT<sup>18</sup>



4420 x 4380 mm  
174 x 172"  
No. 1156



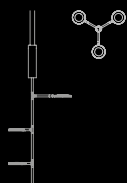




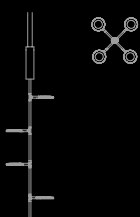
Project: Capital Tower L9, Singapore  
Interior Designer: M Moser Associates  
distributed by Technolite

# AVVENI VERTICAL

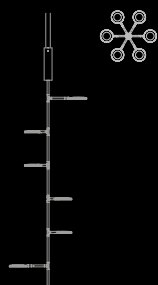
## AVVENI VERTICAL<sup>3|4|6</sup>



H 1574 / W 881  
H 62 / W 34.6"  
No. 1150...



H 1955 / W 881  
H 77 / W 34.6"  
No. 1151...



H 2717 / W 881  
H 107 / W 34.6"  
No. 1152...





Kurparkhotel Bad Wilhelmshöhe,  
distributed by Lichtconcept GmbH

# AVVENI CEILING

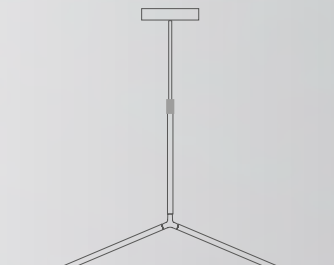
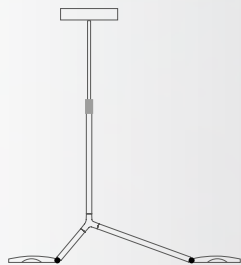
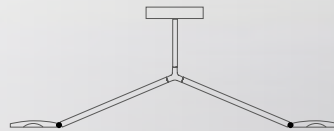
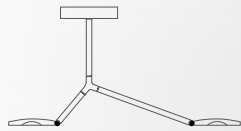
2 x AVVENI CEILING 2







## AVVENI CEILING <sup>2</sup>



### **asymmetrical**

410 x 1007 mm

16.1 x 39.6"

No. 1121...

1070 -1450 x 1007 mm

42.1 - 57.0 x 39.6"

No. 1122...

### **symmetrical**

410 x 1332 mm

16.1 x 52.4"

No. 1117...

1070 -1450 x 1332 mm

42.1 - 57.0 x 52.4"

No. 1118...





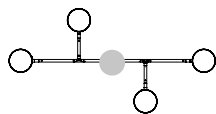
AVVENI PENDANT <sup>6</sup> AVVENI CEILING <sup>2</sup>







AVVENI CEILING <sup>4</sup>



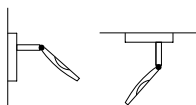
1744 x 882 mm  
68.6 x 34.7"  
No. 1154...





# AVVENI SINGLE

## AVVENI SINGLE



Decken- oder Wandleuchte  
Surface mounted on ceiling or wall  
No. 1112

Ob mit FLOOD oder SPOT Leuchtenkopf: Die AVVENI SINGLE lässt sich individuell und flexibel als Wand- oder Deckenleuchte einsetzen.

Whether as a FLOOD or SPOT version, the AVVENI SINGLE can be used according to individual requirements as a wall or ceiling light.





Salon Mentés, Göppingen

# AVVENI PURE CEILING | WALL

AVVENI PURE



CEILING  
No. 1114



WALL  
No. 1111



Project: REVIDERM, München  
Photo: Michael Heinrich



DERMOKOSMETIK

VERTRÄGLICH  
& WIRKSAM

MADE IN GERMANY

C  
I  
T  
R  
U  
E  
C  
A  
R  
E

REVIDERM

REVIDERM



# AVVENI BRAZO

## AVVENI BRAZO



1057 x 261 mm  
41.6 x 10.3"  
No. 1212







Haus Zochental - Liebel Architekten, Aalen



6 x AVVENI DOWNLIGHT

AVVENI PENDANT 6

# AVVENI DOWNLIGHT



## AVVENI DOWNLIGHT

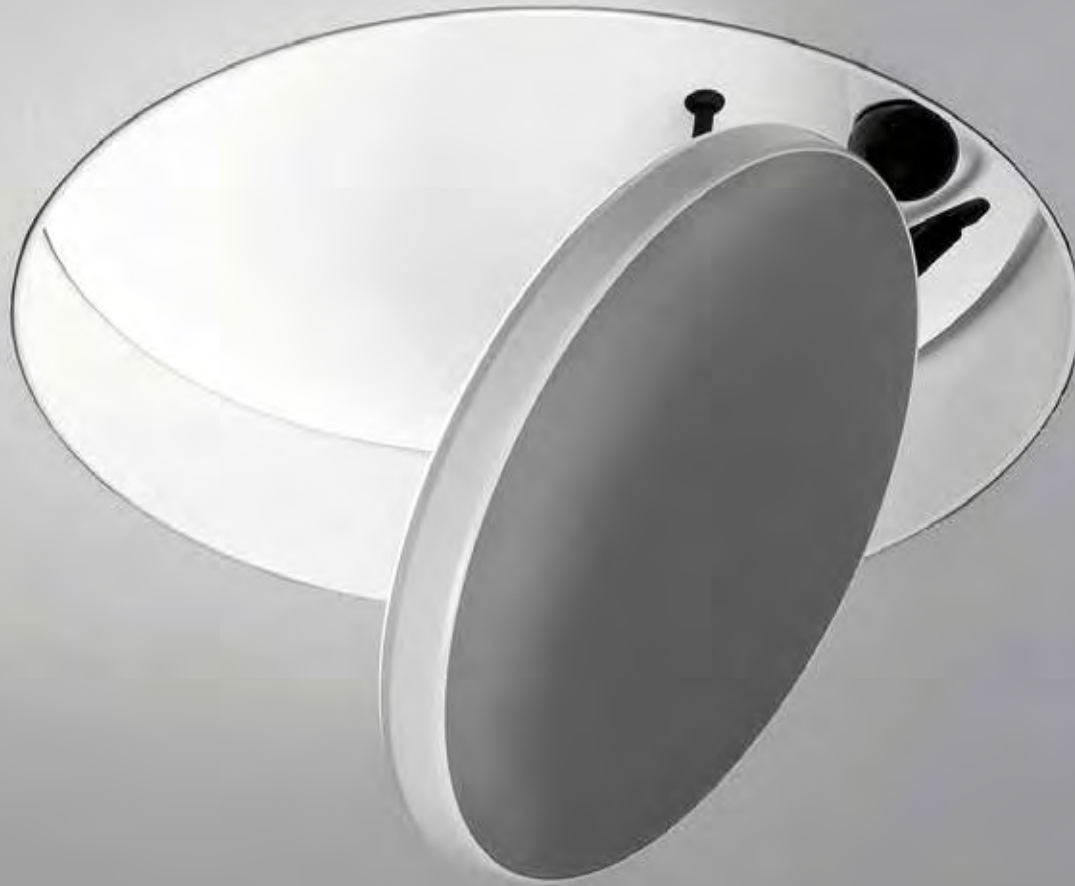


DOWNLIGHT  
WITH FRAME  
No. 1116



DOWNLIGHT  
FRAMELESS  
No. 1115





Schwenk- und drehbar als Strahler oder dezent deckenbündig, der in zwei Varianten erhältliche AVVENI DOWNLIGHT mit rotierbarer Grundplatte bietet einzigartige Anwendungsmöglichkeiten.

The AVVENI DOWNLIGHT can be a swiveling spot light or an unobtrusive flush ceiling light with a rotatable base. Therefore, it offers unique application options.

# AVVENI PURE DOWNLIGHT

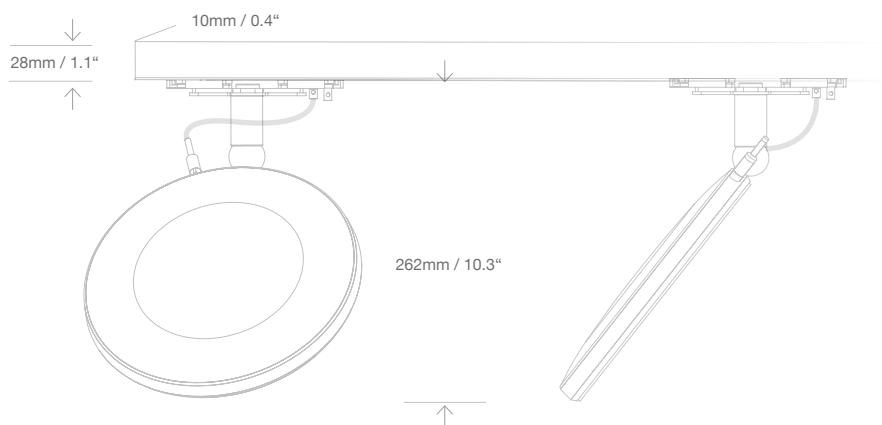
AVVENI PURE DOWNLIGHT



No. 1157



# AVVENI lightlight®



## buschfeld

Durch die Adaption der AVVENI an das lightlight® Stromschienensystem von buschfeld entsteht eine perfekte Symbiose aus Klarheit, Ästhetik und Funktion, die größtmöglichen Spielraum bei der Kreation raumübergreifender Lichtlösungen bietet.

Through the adaption of the AVVENI to the buschfeld lightlight® track system we have a perfect symbiosis of clarity, aesthetics and function, which provides for utmost flexibility in the creation of comprehensive lighting solutions.

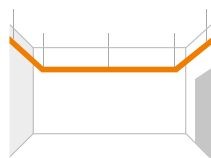
lightlight®

Design: Hans Buschfeld

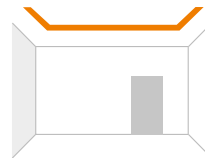
AVVENI  
lightlight®

Schienensystem  
Track system  
No. 1153...

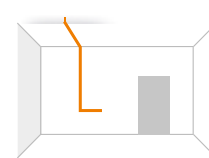
Montageversionen: Mounting versions:



pend36



ceiling36



in36





Montageart: Sonderausführung  
Mounting Version: Special Edition





AVVENI PENDANT 5

AVVENI FLOOR

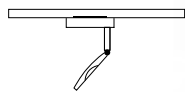


AVVENI 3-PHASE TRACK

# AVVENI 3-PHASE-TRACK



AVVENI  
3-PHASE TRACK



No. 1113









# AVVENI PROJECT

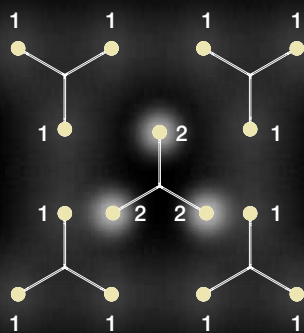
# AVVENI PROJECT

Die Leuchtenserie AVVENI eröffnet bei der Planung und Realisierung komplexer Lichtlösungen z.B. im Büro- und Shopbereich neue Horizonte. Durch die strenge Geometrie und die Modularität der Leuchten lassen sich gleiche oder unterschiedliche Elemente in Gruppen zu einem harmonischen Gesamtbild zusammenfassen. In Kombination mit den lichttechnischen Möglichkeiten und der Beweglichkeit der Leuchtköpfe werden so ausgefallenste Lichtideen und Beleuchtungskonzepte Wirklichkeit.

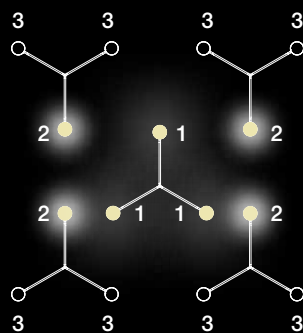
The AVVENI series opens new horizons for the planning and implementation of complex lighting solutions, e.g. in an office or shop area. The luminaires' strict geometry and modular structure permit the harmonious combination of either the same or different grouped elements. Through the bringing together of different AVVENI models along with the movability of the light heads and the possibility to address each light head separately, eccentric lighting ideas can be turned into reality.

AVVENI PENDANT <sup>3</sup>

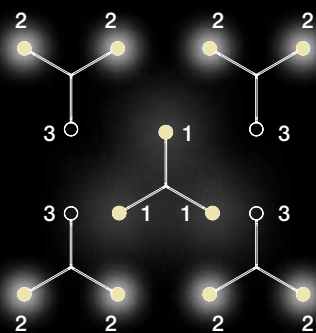
1 – FLOOD, 2 – SPOT, 3 – INDIRECT



Konfiguration / configuration 1



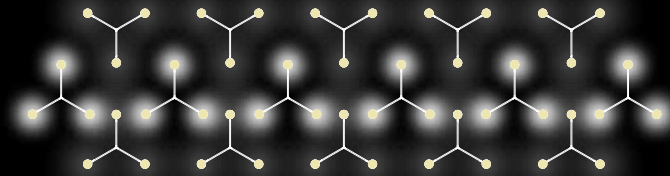
Konfiguration / configuration 2



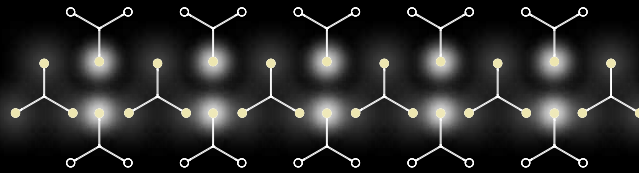
Konfiguration / configuration 3

L-Plan Lighting Design

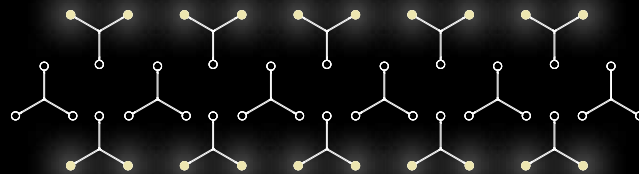
# LIGHTING SOLUTION



Lichtlösung 1  
Light solution 1  
DIRECT / INDIRECT



Lichtlösung 2  
Light solution 2  
DIRECT



Lichtlösung 2  
Light solution 2  
INDIRECT

# AVVENI

Maße mm - inch.

\*Höhenangabe mit Leuchtenkopf

\*Indication of height including light head

Watt

Lumen

Gewicht / weight kg / lbs

## AVVENI TABLE

\*H 560 / Ø 200

\*H 22.0 / Ø 7.9"

17 W

1344 Lumen

2,0 kg / 4.4 lbs

## AVVENI CONCRETE

\*H 315 / Ø 88

\*H 12.4 / Ø 3.5"

max. 19 W

1344 Lumen

2,0 kg / 4.4 lbs

## AVVENI FLOOR

\*H 1260 / Ø 250

\*H 49.6 / Ø 9.8"

max. 19 W

1344 Lumen

4,5 kg / 9.9 lbs

## AVVENI FLOOR

\*H 1760 / Ø 250

\*H 69.3 / Ø 9.8"

max. 19 W

1344 Lumen

4,8 kg / 10.6 lbs

## STRUCTURE

### Type No.

**1100.**



**1155.**



**1105.**



**1106.**



### Finish 1 Structure



**12**  
white matt  
Ral 9003



**14**  
black matt



**22**  
aluminium  
polished

1100. **12.** XX. XX. XX.  
1100. **14.** XX. XX. XX.  
1100. **22.** XX. XX. XX.

1155. **00.** XX. XX. XX.

1105. **12.** XX. XX. XX.  
1105. **14.** XX. XX. XX.  
1105. **22.** XX. XX. XX.

1106. **12.** XX. XX. XX.  
1106. **14.** XX. XX. XX.  
1106. **22.** XX. XX. XX.

### Dimmer



**Push button for dimming**  
**0 - 10V**  
**1 - 10V**  
**DALI**  
**\* CASAMBI**

\*Each head separately switch- and dimmable

1100. XX. **07.** XX. XX.

1155. XX. **08.** XX. XX.

1105. XX. **07.** XX. XX.

1106. XX. **07.** XX. XX.

### Power Supply Cable



**90**  
PVC black

1100. XX. XX. **90.** XX

1155. XX. XX. **90.** XX

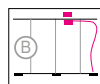
1105. XX. XX. **90.** XX

1106. XX. XX. **90.** XX

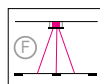
### Mounting Version



Power supply cable  
including country  
specific plug



Suspension with 3 steel  
cables and external power  
supply unit in separate canopy  
or in suspended ceiling



Suspension from canopy  
with 3 current-carrying  
steel cables

1100. XX. XX. XX. **ON.**

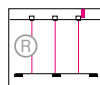
1155. XX. XX. XX. **ON.**

1105. XX. XX. XX. **ON.**

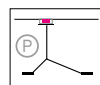
1106. XX. XX. XX. **ON.**



One point suspension  
with pendant canopy  
and current-carrying  
steel cables



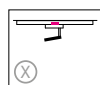
Suspension with 3  
current-carrying steel  
cables and cavity wall  
boxes



Direct ceiling mounting  
with power supply unit  
in canopy



Direct ceiling mounting  
with external power supply



Live track adapter



Recessed in ceiling  
with external power supply

### Light Head Version

FLOOD

FLOOD


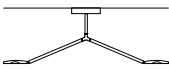
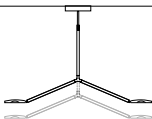


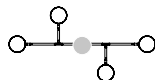












SPOT

FLOOD

SPOT

FLOOD

SPOT

<b>AVVENI FLOOR 3</b>  *H 1822 / Ø 320 *H 71.7 / Ø 12.5"  max. 57 W max. 4032 Lumen 7,2 kg / 15.9 lbs	<b>AVVENI CEILING 2 symmetrical</b>  L 410 / W 1332 L 16.1 / W 52.4"  max. 38 W max. 2688 Lumen 3,2 kg / 7.1 lbs	<b>AVVENI CEILING 2 symmetrical</b>  L 1070-1450 / W 1332 L 42.1 - 57.0 / W 52.4"  max. 38 W max. 2688 Lumen 3,5 kg / 7.7 lbs	<b>AVVENI CEILING 2 asymmetrical</b>  L 410 / W 1007 L 16.1 / W 39.6"  max. 38 W max. 2688 Lumen 3,2 kg / 7.1 lbs	<b>AVVENI CEILING 2 asymmetrical</b>  L 1070-1450 / W 1007 L 42.1 - 57.0 / W 39.6"  max. 38 W max. 2688 Lumen 3,5 kg / 7.7 lbs	<b>AVVENI CEILING 4</b>  L 1744 / W 882 / H 166 L 68.7 / W 34.7 / H 6.5"  max. 76 W max. 5376 Lumen 4,0 kg / 8.2 lbs
					
<b>1110.</b>  1110. <b>12.</b> XX. XX. XX. 1110. <b>14.</b> XX. XX. XX. 1110. <b>22.</b> XX. XX. XX.	<b>1117.</b>  1117. <b>12.</b> XX. XX. XX. 1117. <b>14.</b> XX. XX. XX. 1117. <b>22.</b> XX. XX. XX.	<b>1118.</b>  1118. <b>12.</b> XX. XX. XX. 1118. <b>14.</b> XX. XX. XX. 1118. <b>22.</b> XX. XX. XX.	<b>1121.</b>  1121. <b>12.</b> XX. XX. XX. 1121. <b>14.</b> XX. XX. XX. 1121. <b>22.</b> XX. XX. XX.	<b>1122.</b>  1122. <b>12.</b> XX. XX. XX. 1122. <b>14.</b> XX. XX. XX. 1122. <b>22.</b> XX. XX. XX.	<b>1154.</b>  1154. <b>12.</b> XX. XX. XX. 1154. <b>14.</b> XX. XX. XX. 1154. <b>22.</b> XX. XX. XX.
1110. XX. <b>07.</b> XX. XX.  1110. XX. <b>08.</b> XX. XX.	1117. XX. <b>05.</b> XX. XX. 1117. XX. <b>04.</b> XX. XX. 1117. XX. <b>06.</b> XX. XX. 1117. XX. <b>08.</b> XX. XX.	1118. XX. <b>05.</b> XX. XX. 1118. XX. <b>04.</b> XX. XX. 1118. XX. <b>06.</b> XX. XX. 1118. XX. <b>08.</b> XX. XX.	1121. XX. <b>05.</b> XX. XX. 1121. XX. <b>04.</b> XX. XX. 1121. XX. <b>06.</b> XX. XX. 1121. XX. <b>08.</b> XX. XX.	1122. XX. <b>05.</b> XX. XX. 1122. XX. <b>04.</b> XX. XX. 1122. XX. <b>06.</b> XX. XX. 1122. XX. <b>08.</b> XX. XX.	1154. XX. <b>05.</b> XX. XX. 1154. XX. <b>04.</b> XX. XX. 1154. XX. <b>06.</b> XX. XX. 1154. XX. <b>08.</b> XX. XX.
1110. XX. XX. <b>90.</b> XX	1117. XX. XX. <b>00.</b> XX	1118. XX. XX. <b>00.</b> XX	1121. XX. XX. <b>00.</b> XX	1122. XX. XX. <b>00.</b> XX	1154. XX. XX. <b>00.</b> XX
1110. XX. XX. XX. <b>0N.</b>	1117. XX. XX. XX. <b>0P.</b>	1118. XX. XX. XX. <b>0P.</b>	1121. XX. XX. XX. <b>0P.</b>	1122. XX. XX. XX. <b>0P.</b>	1154. XX. XX. XX. <b>0P.</b>
FLOOD  SPOT 	FLOOD  SPOT 	FLOOD  SPOT 	FLOOD  SPOT 	FLOOD  SPOT 	FLOOD  SPOT 



# AVVENI

Maße mm - inch.

\*Höhenangabe mit Leuchtenkopf

\*Indication of height including light head

Watt

Lumen

Gewicht / weight kg / lbs

## AVVENI SINGLE

Ø 134 / L 285  
Ø 5.3 / L 11.2"

max. 19 W

max. 1344 Lumen

1,6 kg / 3.5 lbs

## AVVENI PURE CEILING

Ø 130 / L 309  
Ø 5.1 / L 12.2"

max. 19 W

max. 1344 Lumen

1,0 kg / 2.2 lbs

## AVVENI PURE WALL

Ø 80 / L 252  
Ø 3.1 / L 9.9"

max. 19 W

max. 1344 Lumen

1,0 kg / 2.2 lbs

## AVVENI 3-PHASE-TRACK

L 314  
L 12.4"

max. 19 W

max. 1344 Lumen

2,0 kg / 4.4 lbs

## STRUCTURE

### Type No.

Finish 1  
Structure



12  
white matt  
Ral 9003



14  
black matt



22  
aluminum  
polished

### Dimmer



Without Dimming

0 - 10V

1 - 10V

DALI

\* CASAMBI

\*Each head separately switch- and dimmable

### Power Supply Cable

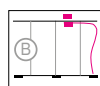


70  
silver

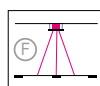
### Mounting Version



Power supply cable including country specific plug



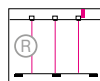
Suspension with 3 steel cables and external power supply unit in separate canopy or in suspended ceiling



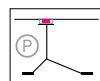
Suspension from canopy with 3 current-carrying steel cables



One point suspension with pendant canopy and current-carrying steel cables



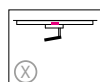
Suspension with 3 current-carrying steel cables and cavity wall boxes



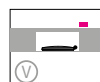
Direct ceiling mounting with power supply unit in canopy



Direct ceiling mounting with external power supply



Live track adapter



Recessed in ceiling with external power supply

1112. XX. XX. XX. **0P.**

1114. XX. XX. XX. **1U.**

Ceiling cutout  
Ø 100 mm / 3.9"

1111. XX. XX. XX. **3U.**

Ceiling cutout  
Ø 68 mm / 2.7"

1113. XX. XX. XX. **0X.**

### Light Head Version

FLOOD

SPOT

FLOOD

SPOT

FLOOD

SPOT

FLOOD

SPOT

### Optional

AVVENI DOWNLIGHT PURE	AVVENI DOWNLIGHT frame / frameless	AVVENI LIGHTLIGHT® Track system	AVVENI VERTICAL <sup>3</sup>	AVVENI VERTICAL <sup>4</sup>	AVVENI VERTICAL <sup>6</sup>
Ø 196 / T 50 Ø 7.7 / T 1.9" max. 19 W max. 1344 Lumen 0,8 kg / 1.8 lbs	Ø 260/240 / T 130/150 Ø 10.2/9.4 / T 5.1/5.9" max. 19 W max. 1344 Lumen 2,5 kg / 5.5 lbs	L 262 L 10.3" max. 19 W max. 1344 Lumen 0,7 kg / 1.5 lbs	H 1574 / W 881 H 62.0 / W 34.7" max. 57 W max. 4032 Lumen 4,7 kg / 10.4 lbs	H 1955 / W 881 H 77.0 / W 34.7" max. 76 W max. 5376 Lumen 5,5 kg / 12.1 lbs	H 2717 / W 881 H 107.0 / W 34.7" max. 114 W max. 8064 Lumen 7,0 kg / 15.4 lbs
<b>1157.</b>	<b>1116.</b>	<b>1153.</b>	<b>1150.</b>	<b>1151.</b>	<b>1152.</b>
1157. <b>00.</b> XX. XX. XX.	1116/15. <b>12.</b> XX. XX. XX.	1153. <b>12.</b> XX. XX. XX. 1153. <b>14.</b> XX. XX. XX. 1153. <b>22.</b> XX. XX. XX.	1150. <b>12.</b> XX. XX. XX. 1150. <b>14.</b> XX. XX. XX. 1150. <b>22.</b> XX. XX. XX.	1151. <b>12.</b> XX. XX. XX. 1151. <b>14.</b> XX. XX. XX. 1151. <b>22.</b> XX. XX. XX.	1152. <b>12.</b> XX. XX. XX. 1152. <b>14.</b> XX. XX. XX. 1152. <b>22.</b> XX. XX. XX.
1157. XX. <b>05.</b> XX. XX. 1157. XX. <b>04.</b> XX. XX. 1157. XX. <b>06.</b> XX. XX. 1157. XX. <b>08.</b> XX. XX.	1116/15. XX. <b>05.</b> XX. XX. 1116/15. XX. <b>04.</b> XX. XX. 1116/15. XX. <b>06.</b> XX. XX. 1116/15. XX. <b>08.</b> XX. XX.	1153. XX. <b>00.</b> XX. XX.  1153. XX. <b>08.</b> XX. XX.	1150. XX. <b>05.</b> XX. XX. 1150. XX. <b>04.</b> XX. XX. 1150. XX. <b>06.</b> XX. XX. 1150. XX. <b>08.</b> XX. XX.	1151. XX. <b>05.</b> XX. XX. 1151. XX. <b>04.</b> XX. XX. 1151. XX. <b>06.</b> XX. XX. 1151. XX. <b>08.</b> XX. XX.	1152. XX. <b>05.</b> XX. XX. 1152. XX. <b>04.</b> XX. XX. 1152. XX. <b>06.</b> XX. XX. 1152. XX. <b>08.</b> XX. XX.
1157. XX. XX. <b>00.</b> XX	1116/15. XX. XX. <b>00.</b> XX	1153. XX. XX. <b>00.</b> XX	1150. XX. XX. <b>70.</b> XX	1151. XX. XX. <b>70.</b> XX	1152. XX. XX. <b>70.</b> XX
1157. XX. XX. XX. <b>1U.</b>	1116/15. XX. XX. XX. <b>1V.</b>	1153. XX. XX. XX. <b>00.</b>	1150. XX. XX. XX. <b>0T.</b>	1151. XX. XX. XX. <b>0T.</b>	1152. XX. XX. XX. <b>0T.</b>
Ceiling cutout 127 mm / 5"	Ceiling cutout <b>1116.</b> Ø 245 mm / 9.6" <b>1115.</b> Ø 248 mm / 9.8"	Individuell konfigurierbares Stromschienen System, siehe Datenblatt  Live track system, see specification sheet for detailed order information.			
FLOOD	FLOOD	FLOOD	FLOOD	FLOOD	FLOOD
SPOT	SPOT	SPOT	SPOT	SPOT	SPOT
<b>Power Supplies</b>	233.00.00.00.00 for 1 Downlight 234.00.00.00.00 for 2 Downlights 235.00.00.00.00 for 4 Downlights 238.00.00.00.00 for 6 Downlights 248.00.00.00.00 for 15 Downlights				

Detaillierte Informationen zu unseren AVVENI Produkten finden Sie auf den jeweiligen Datenblättern unter [www.sattler-lighting.com/produkte](http://www.sattler-lighting.com/produkte)  
 Detailed technical information can be found on our specification sheets under [www.sattler-lighting.com/en/products](http://www.sattler-lighting.com/en/products)

# AVVENI

Maße mm - inch.

\*Höhenangabe mit Leuchtenkopf

\*Indication of height including light head

Watt

Lumen

Gewicht / weight kg / lbs

## AVVENI BRAZO

L 1057 / H 261  
L 41.6 / H 8.5"

max. 19 W

max. 1344 Lumen

2,0 kg / 4.4 lbs

## AVVENI PENDANT 1

Ø 196 / H 101  
Ø 7,7 / H 3.9"

max. 13 W

max. 1027 Lumen

0,8 kg / 1.7 lbs

## AVVENI PENDANT 3

L 1052 / W 936  
L 41.4 / W 36.8"

max. 57 W

max. 4032 Lumen

2,3 kg / 5.1 lbs

## AVVENI PENDANT 3

L 1570 / W 1386  
L 61.8 / W 54.6"

max. 57 W

max. 4032 Lumen

2,6 kg / 5.7 lbs

### STRUCTURE

Type No.

Finish 1  
Structure



12  
white matt  
Ral 9003



14  
black matt



22  
aluminum  
polished

Dimmer



Without Dimming

0 - 10V

1 - 10V

DALI

\* CASAMBI

\*Each head separately switch- and dimmable

Power Supply  
Cable



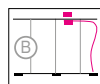
70  
silver

00  
without power supply cable,  
current-carrying suspension  
3000 mm (F + T + R)

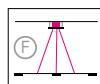
Mounting Version



Power supply cable  
including country  
specific plug



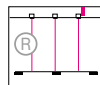
Suspension with steel  
cables and external power  
supply unit in separate canopy  
or in suspended ceiling



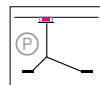
Suspension from canopy  
with current-carrying  
steel cables



One point suspension  
with pendant canopy  
and current-carrying  
steel cables



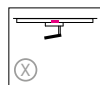
Suspension with  
current-carrying steel  
cables and cavity wall  
boxes



Direct ceiling mounting  
with power supply unit  
in canopy



Direct ceiling mounting  
with external power supply



Live track adapter



Recessed in ceiling  
with external power supply

Light Head Version

FLOOD



SPOT



FLOOD



SPOT



FLOOD



SPOT



FLOOD



SPOT



1212.

1212. 12. XX. XX. XX.  
1212. 14. XX. XX. XX.  
1212. 22. XX. XX. XX.

1211.

1211. 00. XX. XX. XX.

1125.

1125. 12. XX. XX. XX.  
1125. 14. XX. XX. XX.  
1125. 22. XX. XX. XX.

1126.

1126. 12. XX. XX. XX.  
1126. 14. XX. XX. XX.  
1126. 22. XX. XX. XX.

1212. XX. 05. XX. XX.  
1212. XX. 04. XX. XX.  
1212. XX. 06. XX. XX.  
1212. XX. 08. XX. XX.

1211. XX. 05. XX. XX.  
1211. XX. 04. XX. XX.  
1211. XX. 06. XX. XX.  
1211. XX. 08. XX. XX.

1125. XX. 05. XX. XX.  
1125. XX. 04. XX. XX.  
1125. XX. 06. XX. XX.  
1125. XX. 08. XX. XX.

1126. XX. 05. XX. XX.  
1126. XX. 04. XX. XX.  
1126. XX. 06. XX. XX.  
1126. XX. 08. XX. XX.

1212. XX. XX. 00. XX

1211. XX. XX. 82. XX  
black

1125. XX. XX. 70. XX  
1125. XX. XX. 00. XX

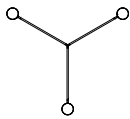
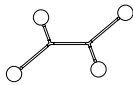
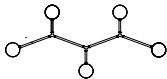
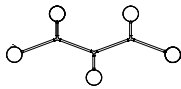
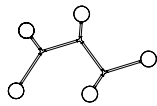
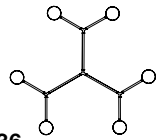












1126. XX. XX. 70. XX  
1126. XX. XX. 00. XX

1125. XX. XX. XX. 0P.

1125. XX. XX. XX. 0F.  
1125. XX. XX. XX. 0R.

1125. XX. XX. XX. 0B.  
1125. XX. XX. XX. 0F.  
1125. XX. XX. XX. 0T.  
1125. XX. XX. XX. 0R.

1126. XX. XX. XX. 0B.  
1126. XX. XX. XX. 0F.  
1126. XX. XX. XX. 0T.  
1126. XX. XX. XX. 0R.

AVVENI PENDANT 3	AVVENI PENDANT 4	AVVENI PENDANT 5	AVVENI PENDANT 5	AVVENI PENDANT 5	AVVENI PENDANT 6
L 2055 / W 1806 L 80.9 / W 71.1" max. 57 W max. 4032 Lumen 2,8 kg / 6.2 lbs	L 1581 / W 957 L 62.2 / W 37.6" max. 76 W max. 5376 Lumen 4,0 kg / 8.8 lbs	L 2208 / W 1043 L 86.9 / W 41.1" max. 95 W max. 6720 Lumen 4,5 kg / 9.9 lbs	L 2960 / W 1111 L 116.5 / W 43.7" max. 95 W max. 6720 Lumen 4,7 kg / 10.4 lbs	L 1959 / W 1372 L 77.1 / W 54.0" max. 95 W max. 6720 Lumen 4,7 kg / 10.4 lbs	L 1625 / W 1434 L 64.0 / W 56.4" max. 108 W max. 8064 Lumen 5,1 kg / 11.2 lbs
					
<b>1127.</b>	<b>1210.</b>	<b>1128.</b>	<b>1129.</b>	<b>1130.</b>	<b>1136.</b>
1127. <b>12.</b> XX. XX. XX. 1127. <b>14.</b> XX. XX. XX. 1127. <b>22.</b> XX. XX. XX.	1210. <b>12.</b> XX. XX. XX. 1210. <b>14.</b> XX. XX. XX. 1210. <b>22.</b> XX. XX. XX.	1128. <b>12.</b> XX. XX. XX. 1128. <b>14.</b> XX. XX. XX. 1128. <b>22.</b> XX. XX. XX.	1129. <b>12.</b> XX. XX. XX. 1129. <b>14.</b> XX. XX. XX. 1129. <b>22.</b> XX. XX. XX.	1130. <b>12.</b> XX. XX. XX. 1130. <b>14.</b> XX. XX. XX. 1130. <b>22.</b> XX. XX. XX.	1136. <b>12.</b> XX. XX. XX. 1136. <b>14.</b> XX. XX. XX. 1136. <b>22.</b> XX. XX. XX.
1127. XX. <b>05.</b> XX. XX. 1127. XX. <b>04.</b> XX. XX. 1127. XX. <b>06.</b> XX. XX. 1127. XX. <b>08.</b> XX. XX.	1210. XX. <b>05.</b> XX. XX. 1210. XX. <b>04.</b> XX. XX. 1210. XX. <b>06.</b> XX. XX. 1210. XX. <b>08.</b> XX. XX.	1128. XX. <b>05.</b> XX. XX. 1128. XX. <b>04.</b> XX. XX. 1128. XX. <b>06.</b> XX. XX. 1128. XX. <b>08.</b> XX. XX.	1129. XX. <b>05.</b> XX. XX. 1129. XX. <b>04.</b> XX. XX. 1129. XX. <b>06.</b> XX. XX. 1129. XX. <b>08.</b> XX. XX.	1130. XX. <b>05.</b> XX. XX. 1130. XX. <b>04.</b> XX. XX. 1130. XX. <b>06.</b> XX. XX. 1130. XX. <b>08.</b> XX. XX.	1136. XX. <b>05.</b> XX. XX. 1136. XX. <b>04.</b> XX. XX. 1136. XX. <b>06.</b> XX. XX. 1136. XX. <b>08.</b> XX. XX.
1127. XX. XX. <b>70.</b> XX 1127. XX. XX. <b>00.</b> XX	1210. XX. XX. <b>70.</b> XX 1210. XX. XX. <b>00.</b> XX	1128. XX. XX. <b>70.</b> XX 1128. XX. XX. <b>00.</b> XX	1129. XX. XX. <b>70.</b> XX 1129. XX. XX. <b>00.</b> XX	1130. XX. XX. <b>70.</b> XX 1130. XX. XX. <b>00.</b> XX	1136. XX. XX. <b>70.</b> XX 1136. XX. XX. <b>00.</b> XX
1127. XX. XX. XX. <b>0B.</b> 1127. XX. XX. XX. <b>0F.</b> 1127. XX. XX. XX. <b>0T.</b> 1127. XX. XX. XX. <b>0R.</b>	1210. XX. XX. XX. <b>0B.</b> 1210. XX. XX. XX. <b>0F.</b> 1210. XX. XX. XX. <b>0R.</b>	1128. XX. XX. XX. <b>0B.</b> 1128. XX. XX. XX. <b>0F.</b> 1128. XX. XX. XX. <b>0R.</b>	1129. XX. XX. XX. <b>0B.</b> 1129. XX. XX. XX. <b>0F.</b> 1129. XX. XX. XX. <b>0R.</b>	1130. XX. XX. XX. <b>0B.</b> 1130. XX. XX. XX. <b>0F.</b> 1130. XX. XX. XX. <b>0R.</b>	1136. XX. XX. XX. <b>0B.</b> 1136. XX. XX. XX. <b>0F.</b> 1136. XX. XX. XX. <b>0T.</b>
FLOOD  SPOT 	FLOOD  SPOT 	FLOOD  SPOT 	FLOOD  SPOT 	FLOOD  SPOT 	FLOOD  SPOT 

# AVVENI

Maße mm - inch.

\*Höhenangabe mit Leuchtenkopf

\*Indication of height including light head

Watt

Lumen

Gewicht / weight kg / lbs

## AVVENI PENDANT 6

L 1948 / W 1800  
L 76.7 / W 70.8"

max. 114 W

max. 8064 Lumen

5,4 kg / 11.9 lbs

## AVVENI PENDANT 6

L 2658 / W 1043  
L 105.0 / W 41.1"

max. 114 W

max. 8064 Lumen

5,3 kg / 11.7 lbs

## AVVENI PENDANT 8

L 2679 / W 1301  
L 105.5 / W 51.2"

max. 152 W

max. 10752 Lumen

7,1 kg / 15.7 lbs

## AVVENI PENDANT 18

L 4420 / W 4380  
L 174 / W 172"

max. 324 W

max. 24192 Lumen

20,0 kg / 44.1 lbs

## STRUCTURE

Type No.

Finish 1  
Structure



12  
white matt  
Ral 9003



14  
black matt



22  
aluminum  
polished

Dimmer



Without Dimming

0 - 10V

1 - 10V

DALI

\* CASAMBI

\*Each head separately switch- and dimmable

Power Supply  
Cable



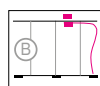
70  
silver

00  
without power supply cable,  
current-carrying suspension  
3000 mm (F + T + R)

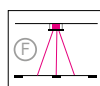
Mounting Version



Power supply cable  
including country  
specific plug



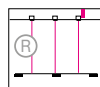
Suspension with steel  
cables and external power  
supply unit in separate canopy  
or in suspended ceiling



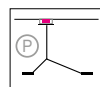
Suspension from canopy  
with current-carrying  
steel cables



One point suspension  
with pendant canopy  
and current-carrying  
steel cables



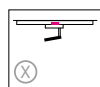
Suspension with  
current-carrying steel  
cables and cavity wall  
boxes



Direct ceiling mounting  
with power supply unit  
in canopy



Direct ceiling mounting  
with external power supply



Live track adapter



Recessed in ceiling  
with external power supply

Light Head Version

FLOOD



SPOT



FLOOD



SPOT



FLOOD



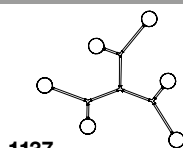
SPOT



FLOOD

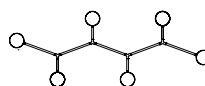


SPOT



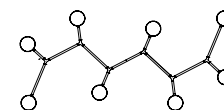
1137.

1137. 12. XX. XX. XX.  
1137. 14. XX. XX. XX.  
1137. 22. XX. XX. XX.



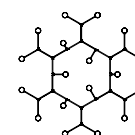
1135.

1135. 12. XX. XX. XX.  
1135. 14. XX. XX. XX.  
1135. 22. XX. XX. XX.



1140.

1140. 12. XX. XX. XX.  
1140. 14. XX. XX. XX.  
1140. 22. XX. XX. XX.



1156.

1156. 12. XX. XX. XX.  
1156. 14. XX. XX. XX.  
1156. 22. XX. XX. XX.

1137. XX. 05. XX. XX.  
1137. XX. 04. XX. XX.  
1137. XX. 06. XX. XX.  
1137. XX. 08. XX. XX.

1135. XX. 05. XX. XX.  
1135. XX. 04. XX. XX.  
1135. XX. 06. XX. XX.  
1135. XX. 08. XX. XX.

1140. XX. 05. XX. XX.  
1140. XX. 04. XX. XX.  
1140. XX. 06. XX. XX.  
1140. XX. 08. XX. XX.

1156. XX. 05. XX. XX.  
.  
1156. XX. 08. XX. XX.

1137. XX. XX. 70. XX  
1137. XX. XX. 00. XX

1135. XX. XX. 70. XX

1140. XX. XX. 70. XX

1156. XX. XX. 70. XX

1137. XX. XX. XX. 0B.  
1137. XX. XX. XX. 0F.  
1137. XX. XX. XX. 0T.

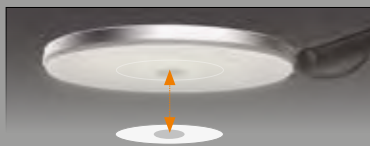
1135. XX. XX. XX. 0B.

1140. XX. XX. XX. 0B.

1140. XX. XX. XX. 0B.



## AVVENI ACCESSORIES









AVVENI Leuchten mit 9° Spot bieten durch das integrierte SNAP-SYSTEM verschiedene Möglichkeiten, sich nachträglich dem jeweiligen Bedarf anzupassen. So können Abstrahlwinkel und -form, sowie die Farbtemperatur mittels magnetischer Filterscheiben geändert und bis zu drei Filter miteinander kombiniert werden.

AVVENI luminaires with 9° spot offer various ways of adaption to any customer's requirements by use of the integrated SNAP SYSTEM. Beam angle and shape as well as the colour temperature may be changed using magnetic snap-on lenses. Up to three lenses can be combined.

### BEAM ANGLE LENSES



**Spot-light lenses\*** magnetic snap-on lenses to change the beam angle

	<b>17°</b>		Spot	<b>1174.</b> 00. 00. 00. 00
	<b>25°</b>		Spot	<b>1163.</b> 00. 00. 00. 00
	<b>36°</b>		Spot	<b>1164.</b> 00. 00. 00. 00
	<b>60°</b>		Spot	<b>1165.</b> 00. 00. 00. 00
	<b>13°</b>		Spot asymmetrical 0-20°, consisting of 2 lenses	<b>1177.</b> 00. 00. 00. 00

**Elliptical lens\*** magnetic snap-on lenses for asymmetrical light beam
















	<b>10-36°</b>		Ellipse*	<b>1166.</b> 00. 00. 00. 00
	<b>10-60°</b>		Ellipse*	<b>1175.</b> 00. 00. 00. 00

**Square lens\*** magnetic snap-on lenses for square light beam

	<b>36°-36°</b>		Square* *approx. 10% reduction of the lumen output	<b>1176.</b> 00. 00. 00. 00
---	----------------	---	---	-----------------------------

### LIGHT COLOUR LENSES

**Colour temperatur lenses\*** magnetic snap-on lenses that shift colour temperature

Starting light colour KELVIN (K)	2700 	3000 	4000 	
 <b>CTO 1/4</b>	<b>2450</b> 	<b>2700</b> 	<b>3500</b> 	<b>1160.</b> 00. 00. 00. 00
 <b>CTO 1/2</b>	<b>2200</b> 	<b>2400</b> 	<b>3000</b> 	<b>1161.</b> 00. 00. 00. 00
 <b>CTO 3/4</b>	<b>2000</b> 	<b>2200</b> 	<b>2700</b> 	<b>1162.</b> 00. 00. 00. 00

\*reduction of the lumen output : CTO 1/4 = 10%, CTO 1/2 = 25%, CTO 3/4 = 40%

### ANTI GLARE PROTECTION

**Louwer snap** magnetic snap-on adaptor to eliminate high angle glare

	<b>1167.</b> 00. 00. 00. 00
---	-----------------------------

## AVVENI LIGHT HEAD

Die Leuchten des AVVENI-Systems können mit zwei unterschiedlichen Leuchtenköpfen bestückt werden. FLOOD- und SPOT-Leuchtenköpfe können jederzeit gewechselt werden. Zudem ist auch der Einsatz von unterschiedlichen Leuchtentypen an einer Struktur möglich.

The AVVENI series allows for two different light heads: FLOOD and SPOT. The FLOOD and SPOT heads can be exchanged at any time. Moreover, the two distinct heads may be combined within any AVVENI structure.

### LIGHT HEAD

#### Type No.

**01.** XX. XX. XX. XX. XX. XX.  
**02.** XX. XX. XX. XX. XX. XX. (only No. 1157)

#### Finish 2 Light head outside ring



**12**  
white matt  
Ral 9003



**62 (14)**  
black  
matt



**22**  
aluminum  
polished



Finish 2 must be the same as finish 1

XX. **12.** XX. XX. XX. XX. XX.  
 XX. **62.** XX. XX. XX. XX. XX.  
 XX. **22.** XX. XX. XX. XX. XX. (not possible No. 1157)

#### Finish 3 Light head top cover



**60**  
silver  
anodised



**61**  
gold  
anodised



**62**  
black  
anodised



XX. XX. **60.** XX. XX. XX. XX.  
 XX. XX. **61.** XX. XX. XX. XX.  
 XX. XX. **62.** XX. XX. XX. XX.

#### LED 36V, CRI >95



**Extra warm-white 2700 K**  
**Warm-white 3000 K**  
**Neutral-white 4000 K**

XX. XX. XX. **27.** XX. XX. XX.  
 XX. XX. XX. **30.** XX. XX. XX.  
 XX. XX. XX. **40.** XX. XX. XX.

#### Beam Angle

##### FLOOD

Watt Lumen  
**17 W 1344<sup>1</sup>**



XX. XX. XX. XX. **99.** 00. 00

\* Spot 9° with spot-light transformer via snap-system

**SPOT 9° 19 W 1268<sup>1</sup>**

**\*SPOT 25° 19 W 1174<sup>1</sup>**



XX. XX. XX. XX. **09.** 00. 00

**Spot 15,5 W**  
**General light 3,5 W**

**\*SPOT 36° 19 W 1174<sup>1</sup>**

**\*SPOT 60° 19 W 1174<sup>1</sup>**

XX. XX. XX. XX. **36.** 00. 00

XX. XX. XX. XX. **60.** 00. 00

#### How to order... FAQs

1. Light Structure	> Type No.	> Finish 1	> Dimmer	> Power supply cable	> Mounting version
2. Light Head	> Type No.	> Finish 2	> Finish 3	> LED light colour	> FLOOD or SPOT > Beam Angle

## TECHNISCHE INFORMATIONEN | TECHNICAL INFORMATION



### Positive Ökobilanz:

Unsere Leuchten sind mit LED-Technologie der neuesten Generation ausgestattet, sind energiesparend, langlebig, sparen CO<sub>2</sub> und schonen damit Umwelt und Klima. Die Verwendung ausgesuchter Materialien sichert, dass nahezu alle Leuchtenbauteile umweltfreundlich recycelt werden können.

### Environmentally Conscious:

Our lights are equipped with the latest in LED technology, which is energy saving and long-lasting, therefore preserving the environment. The use of well selected materials, guarantees an environmentally friendly recycling process of almost every component.



Diese Leuchten enthalten eingebaute LED-Lampen:  
These lamps have built-in LED lights:

AVVENI PURE TRACK SYSTEM  
AVVENI 3-PHASE-TRACK  
AVVENI TABLE  
AVVENI FLOOR  
AVVENI CONCRETE  
AVVENI PENDANT  
AVVENI VERTICAL  
AVVENI CEILING  
AVVENI SINGLE  
AVVENI PURE CEILING / WALL  
AVVENI BRAZO  
AVVENI DOWNLIGHT  
AVVENI PURE DOWNLIGHT

874-2012



Erfüllt die Anforderungen aller für dieses Produkt gültigen EG-Richtlinien.  
Meets the requirements of all applicable to this product EC directives.



Für diese Produkte können Lichtverteilungskurven angefordert werden.  
For this product light distribution curves may be requested.



Deutsche Wertarbeit,  
Zertifizierte Qualität  
Handcrafted in Germany,  
certified quality



Schutzart  
Protective rating



Lichtverteilung  
Light distribution



Gewicht beachten, ausreichende Deckenbelastbarkeit sicherstellen  
Sufficient load capacity of the ceiling structure has to be ensured



Bluetooth CASAMBI  
Steuerung mit App  
remote control through app



Produkte die mit diesem Zeichen versehen sind, wurden nach UL-Sicherheitsstandards für den US-amerikanischen und kanadischen Markt getestet und zertifiziert. Einzelne Produktvariationen können jedoch von der Zertifizierung ausgenommen sein. Bitte fragen Sie im Zweifel bei uns nach.  
„Conforms to UL-STD 1598, Certified to CSA-STD C22.2 No. 250.0-08“

Products with this mark have been tested and certified to comply with UL safety standards for the US-American and Canadian market. Some product characteristics, however, may not bear the certification. Please do not hesitate to contact us in case of doubt.  
„Conforms to UL-STD 1598, Certified to CSA-STD C22.2 No. 250.0-08“



Zur Montage auf entflammaren Baustoffen, deren Entzündungstemperatur mindestens 200° C beträgt geeignet.

Luminaires are suitable for mounting on ordinary flammable materials, which have an inflammation point of at least 200° C.



Schutzklasse  
Protection class



Dimmung  
Dimmable



LED-Lichttechnik 36V: 2700K, 3000K, 4000K  
LED-technology 36V: 2700K, 3000K, 4000K

Technische Änderungen, Irrtümer und Druckfehler vorbehalten

- 1) Tatsächlicher Lumenwert: Verluste durch Diffusoren und Reflektoren sind berücksichtigt. Die Lumen-Werte beziehen sich auf eine Umgebungstemperatur von max. 30°C / 95°F.
- 2) Leuchtengewichte ohne separate Technischeinheit oder Baldachin.

Technical data subject to change. Errors and omissions excepted 1) Net lumen output: Losses due to diffusers and reflectors are considered. Lumen values refer to an ambient temperature of max. 35° C / 95° F.  
2) Weight of lights without remote technical unit or canopy.

SATTLER GmbH

Wilhelm-Zwick-Str. 6  
73035 Göppingen - Germany

Phone: +49 (0) 7161 / 920 193 - 0

E-Mail: [info@sattler-lighting.com](mailto:info@sattler-lighting.com)

Export Department:

Phone: +49 (0) 7161 / 920 193 - 50

eMail: [export@sattler-lighting.com](mailto:export@sattler-lighting.com)

[www.sattler-lighting.com](http://www.sattler-lighting.com)

SATTLER