



# LED PUCK AIR

## CATENARY LIGHTING REIMAGINED

LED Puck Air is the incredibly lightweight, highly versatile, and exceptionally elegant catenary lighting system for today's modern world. High performance yet only a fraction of the size and weight of other systems, Air enables safe, reliable, clutter-free catenary and welcomes infinite design possibilities for everything from outdoor gathering spaces to indoor accent lighting.

### APPLICATIONS

- Outdoor
- Indoor
- High-end Retail
- Display Case
- Art Galleries & Museums

### OPTIONS & ACCESSORIES

Air comes available in a range of body and distribution types. Customise your Air with options and interchangeable accessories. See page 2 and our *Spec Your LED Puck Air Code Reference* sheets.

## SPECIFICATIONS

### TECHNICAL

- 8W
- CRI 80+ (CRI 90+ OPTION)
- 3 STEP MACADAM ELLIPSE
- B<sub>50</sub> L<sub>70</sub> >100,000h

### PERFORMANCE

- UP TO 850 LUMENS (8W @ 4000K)
- OVER 100LM/W

### OPTICS

- POLYCARBONATE / PMMA

### DISTRIBUTION

- AVAILABLE IN A RANGE OF DISTRIBUTIONS:
- CIRCULAR / OVAL / DECORATIVE (SEE FOLLOWING PAGES)

### MATERIAL

- MARINE GRADE ALUMINIUM (STANDARD)

### FINISH

- ANODIZED BLACK MATTE (STANDARD)
- LENS RING COLOUR OPTIONS AVAILABLE

### AMBIENT OPERATING CONDITIONS

- MIN. -40° / MAX. 55°

### PROTECTION CLASS\*

- POLYCARBONATE IP67 / IK10

### ELECTRICAL

- VOLTAGE 24V

### INSTALLATION

- Ø3MM TWIN CABLE SUSPENSION (SUPPLIED BY MANUFACTURER)

### CONTROL

- GLOBAL: 0-10, DALI, PHASE, CASAMBI;
- INDIVIDUAL: DALI, CASAMBI

### DIMENSIONS & WEIGHT

- Ø25MM X 150MM LUMINAIRE
- 100 GRAMS PER LUMINAIRE

### CABLE SPECIFICATIONS

- SINGLE CORE 1.00MM<sup>2</sup> TINNED COPPER WITH KEVLAR BRAID

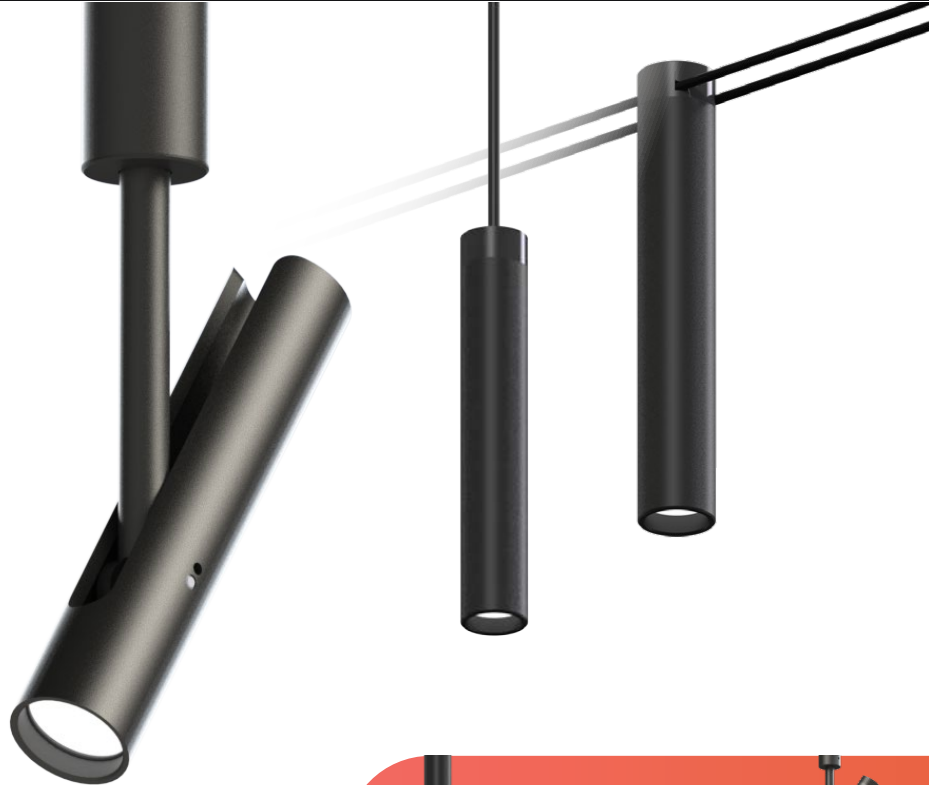

*Air comes in Standard, Axis (Pan & Tilt), and Pendant body types.*



ETLus conforms to UL2108 cETL conforms to CSA C22.2 #250.0

\*Note, Zoom rated IP63

\*Specifications are subject to change without notice.  
[planetlighting.com/led-puck](http://planetlighting.com/led-puck) ver. 03082021-00 01



BODY OPTIONS

LED PUCK AIR



Get creative with LED Puck Air's clever family of options. Choose either Standard, Axis or Pendant body type, then select your distribution. Interchangeable accessories and options are also available. See our *Air Options* and *Spec Your LED Puck Air Code Reference* for more details.

STANDARD  
BODY

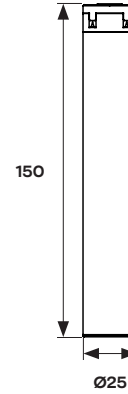
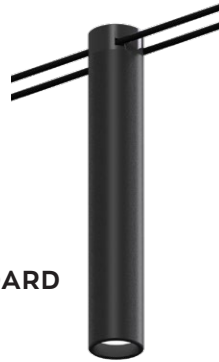

AXIS BODY  
(PAN & TILT)

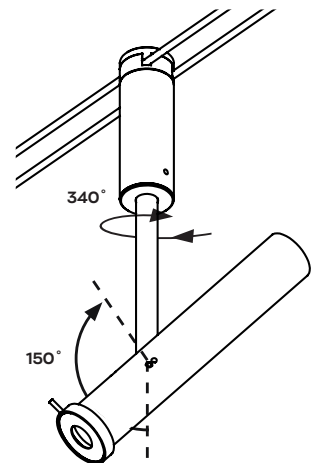

*Choose Standard, Axis or Pendant body type. Final dimensions will vary depending on which options are chosen*

PENDANT  
BODY

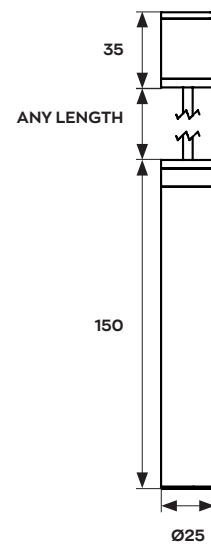

All Dimensions in millimetres (mm).

\*Specifications are subject to change without notice.



DISTRIBUTION OPTIONS

LED PUCK AIR

SERIES

DISTRIBUTION

DESCRIPTION

AIR DIRECTOR

Precise, high uniformity and limitless flexibility, our Air Director series lets you sculpt with light with incredible control.

Air Shoot



Symmetrical beam with limiter producing a narrow spot with zero side spill

Air Spot



Symmetrical and precise extra narrow spot

Air Narrow



Symmetrical, precise narrow spot

Air Medium



Symmetrical, precise medium spot

Air Wide



Symmetrical wide spot

Air Oval



Wide elliptical beam

Air Square



Ultra-wide square batwing

Air Line



Ultra-wide line batwing

Air Zoom



Flexible focus beam adjustment from narrow to wide

Air Iris



Adjustable beam limiter from narrow to wide

SERIES

DISTRIBUTION

DESCRIPTION

AIR BRILLIANT

Decorative and diffuse distribution options to set the mood and ambience.

Air Diamond



Cut glass with high refractive effect producing a distinct star-shaped pattern and bright centre point

Air Prism



Cut glass with a soft but defined kaleidoscope effect

Air Wand



Modern festoon dual lighting effect

Air Globe



Modern festoon lantern. Choose from Globe Closed, Globe Open, Globe Half, Globe Silver, Globe Frosted or Globe Glass.







## COLOUR OPTIONS

LED PUCK AIR

Choose your colour.

### COLOUR









2700K		Tunable White <sup>†</sup>	
3000K		RGBW <sup>†</sup>	
4000K			



Engineer the experience with LED Puck Air's family of options. See our *Spec Your LED Puck Air Code Reference* sheets.

## ACCESSORIES, FINISHES & EXTRA OPTIONS

Choose your finish, accessories and any additional options. LED Puck Air comes standard in anodized black marine grade aluminium with matching lens ring.

FINISH / ACCESSORY		DESCRIPTION
Black Matte Body (Standard)		Anodized standard black marine grade aluminium
Black Lens Ring Finish (Standard)		Standard black lens ring finish
Gold Lens Ring Finish		Gold lens ring finish
Silver Lens Ring Finish		Silver lens ring finish
Painted Finish		Painted finish (please specify / contact us)
CRI 90		CRI90+
Barn Doors		4 door adjustable barn doors
Air Lens Cover		Polycarbonate lens cover



## MOUNTING HARDWARE SETS

LED PUCK AIR

Drawings Not to Scale

A range of mounting parts are available for catenary including Pole Mounts, Eyebolts for Timber, Masonry and Metal, and a Universal Plate Mount. Sets come complete with Mount, Turnbuckles, blocks and grub screws. Cable and Drivers are available separately.

Total Installed horizontal loading:  
40-50kg tensile force

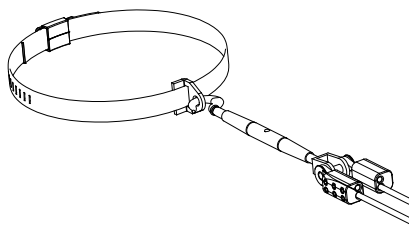

Pole (or tree) Mount

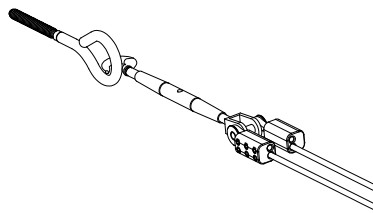

Eyebolt Mount:  
Timber, Masonry, Metal

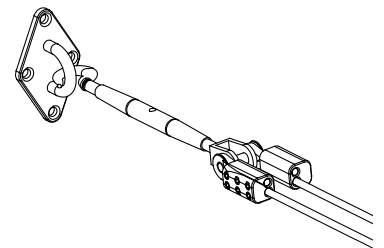

Universal Plate Mount

## CONNECTION

LED Puck Air has a combined all-in-one twin cable suspension and power system, including Dim over power. There is no need for a separate power cable.

Air will conveniently mount and connect simultaneously via its screw on/off cap making repositioning simple.

instant mounting and connection via Air's screw on cap\*.

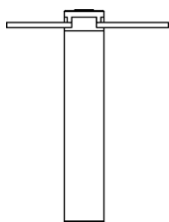

Luminaire Connected (Cap On)  
Side View

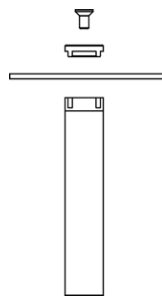

Luminaire Disconnected (Cap Off)  
Side View & Isometric

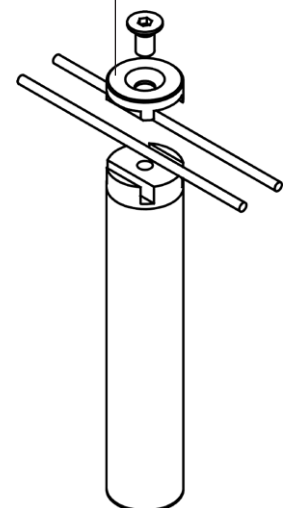



TYPICAL SPECIFICATIONS

LED PUCK AIR

Table of standard specifications

PRODUCT CODE	STANDARD SPECIFICATION
AIR DIRECTOR SERIES	
AIR-CAT-ST-SN-30	Air Catenary Standard Body Snoot Spot 3000K
AIR-CAT-ST-SN-40	Air Catenary Standard Body Snoot Spot 4000K
AIR-CAT-AX-SN-30	Air Catenary Axis Body Snoot Spot 3000K
AIR-CAT-AX-SN-40	Air Catenary Axis Body Snoot Spot 4000K
AIR-CAT-ST-LN-30	Air Catenary Standard Body Narrow Beam 3000K
AIR-CAT-ST-LN-40	Air Catenary Standard Body Narrow Beam 4000K
AIR-CAT-AX-LN-30	Air Catenary Axis Body Narrow Beam 3000K
AIR-CAT-AX-LN-40	Air Catenary Axis Body Narrow Beam 4000K
AIR-CAT-ST-LM-30	Air Catenary Standard Body Medium Beam 3000K
AIR-CAT-ST-LM-40	Air Catenary Standard Body Medium Beam 4000K
AIR-CAT-AX-LM-30	Air Catenary Axis Body Medium Beam 3000K
AIR-CAT-AX-LM-40	Air Catenary Axis Body Medium Beam 4000K
AIR-CAT-ST-LW-30	Air Catenary Standard Body Wide Beam 3000K
AIR-CAT-ST-LW-40	Air Catenary Standard Body Wide Beam 4000K
AIR-CAT-AX-LW-30	Air Catenary Axis Body Wide Beam 3000K
AIR-CAT-AX-LW-40	Air Catenary Axis Body Wide Beam 4000K
AIR-CAT-ST-LO-30	Air Catenary Standard Body Oval Beam 3000K
AIR-CAT-ST-LO-40	Air Catenary Standard Body Oval Beam 4000K
AIR-CAT-AX-LO-30	Air Catenary Axis Body Oval Beam 3000K
AIR-CAT-AX-LO-40	Air Catenary Axis Body Oval Beam 4000K
AIR-CAT-ST-ZO-30	Air Catenary Standard Body Zoom Variable Beam 3000K
AIR-CAT-ST-ZO-40	Air Catenary Standard Body Zoom Variable Beam 4000K
AIR-CAT-AX-ZO-30	Air Catenary Axis Body Zoom Variable Beam 3000K
AIR-CAT-AX-ZO-40	Air Catenary Axis Body Zoom Variable Beam 4000K
AIR-CAT-AX-IR-30	Air Catenary Axis Body Iris 3000K
AIR-CAT-AX-IR-40	Air Catenary Axis Body Iris 4000K



Engineer the experience with LED Puck Air's family of options. See our *Spec Your LED Puck Air Code Reference* sheets.



TYPICAL SPECIFICATIONS

LED PUCK AIR

Table of standard specifications

PRODUCT CODE	STANDARD SPECIFICATION
AIR BRILLIANT SERIES	
AIR-CAT-ST-WA-30	Air Catenary Standard Body Wand 3000K
AIR-CAT-ST-DI-30	Air Catenary Standard Body Diamond 3000K
AIR-CAT-ST-PR-30	Air Catenary Standard Body Prism 3000K
AIR-CAT-ST-GC-30	Air Catenary Standard Body Globe Closed 3000K
AIR-CAT-ST-GO-30	Air Catenary Standard Body Globe Open 3000K
AIR-CAT-ST-GG-30	Air Catenary Standard Body Globe Glass 3000K
MOUNTING HARDWARE AND POWER SUPPLY	
AIR-CABLE	Single Core Kevlar Reinforced Copper Cable
AIR-PS-120	120W Power Supply 0-10V Dim Drives x 10 Puck Airs
AIR-PS-240	240W Power Supply 0-10V Dim Drives x 20 Puck Airs
AIR-PS-480	480W Power Supply 0-10V Dim Drives x 40 Puck Airs
POW/NON-TIM	Timber Eyebolt Mount Hardware Set for powered or non-powered end.
POW/NON-MAS	Masonry Eyebolt Mount Hardware Set for powered or non-powered end.
POW/NON-MET	Metal Eyebolt Mount Hardware Set for powered or non-powered end.
POW/NON-XXX	Pole/Tree Hardware Mount Set for powered or non-powered end. Please specify pole diameter in mm [XXX]
POW/NON-PLA	Universal Plate Mount Hardware Set for powered or non-powered end.



Ask Us.

Your success is important to us.  
Get in touch with your  
Planet LED Puck supplier today.