



dezzi
DOWNLIGHT FAMILY





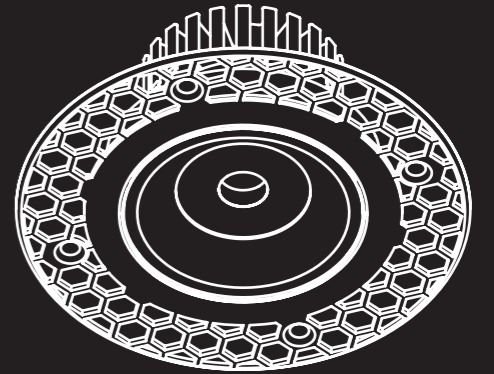
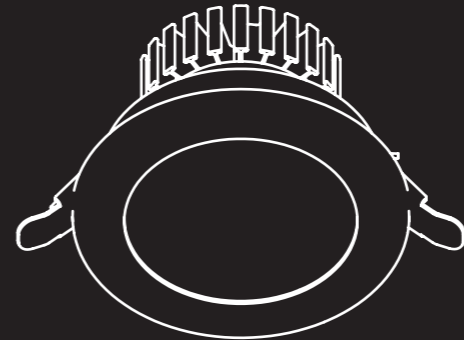
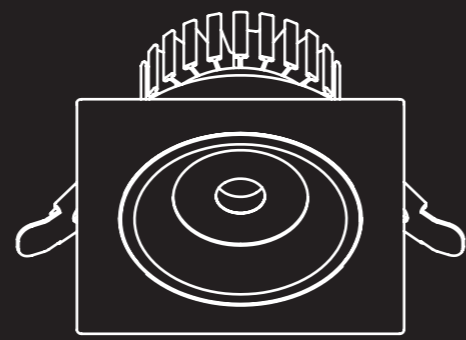
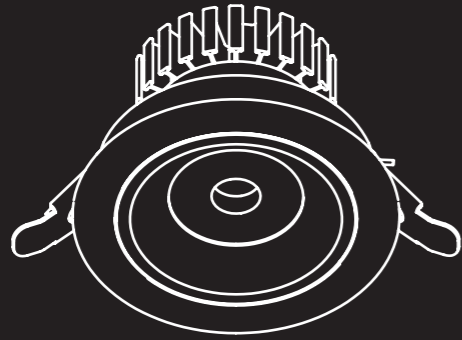

FIXED



ADJUSTABLE

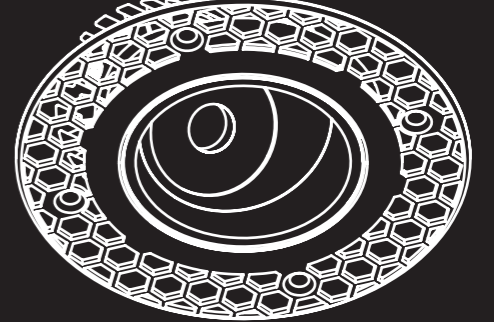
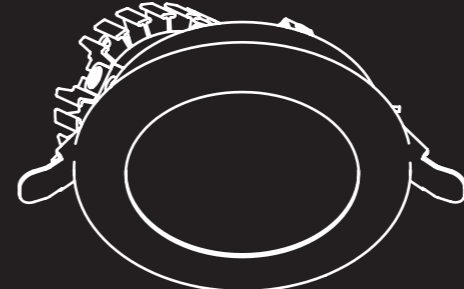

WALLWASH

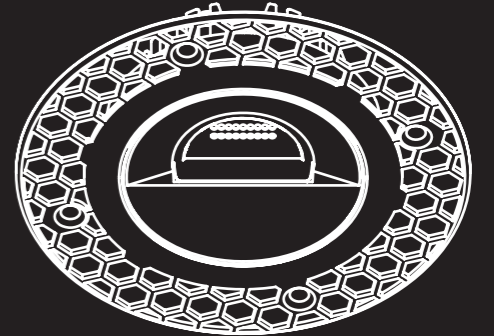
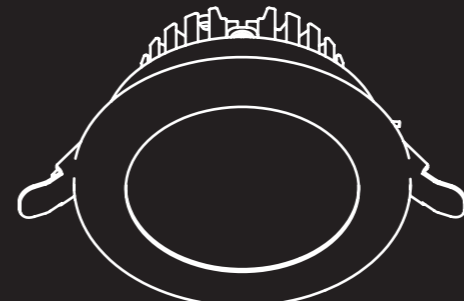
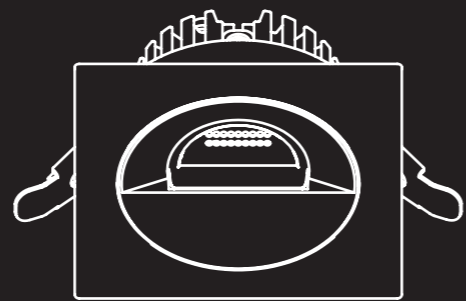
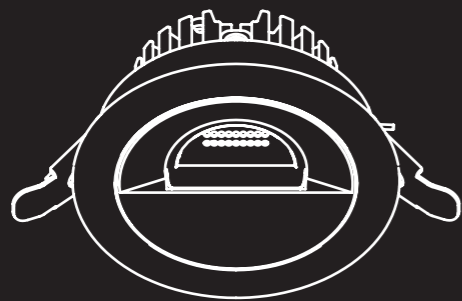

PIN HOLE

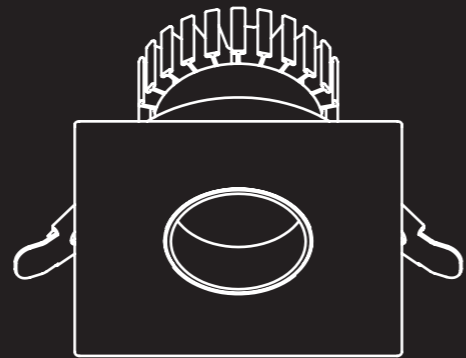
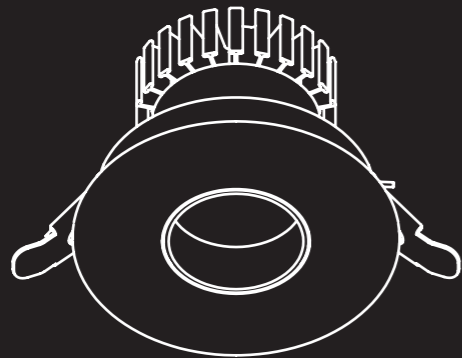



Light Source



Output

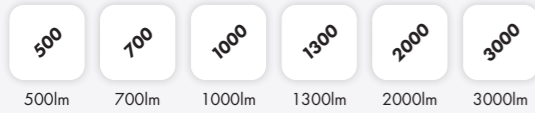

Colour Temperature

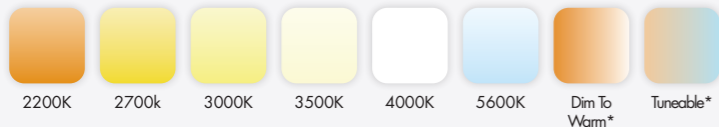

Colour Fidelity

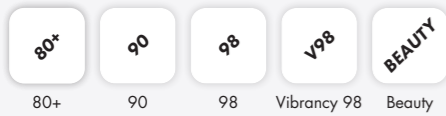

Beam Angle



Trim Colour

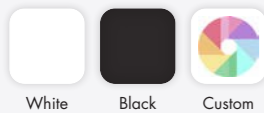

Bezel Colour

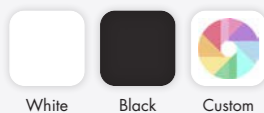

Accessories

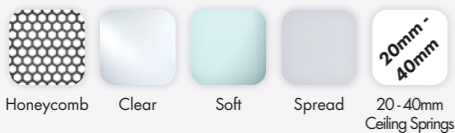

*available on request.

dezzi

DEZZI FIXED ROUND

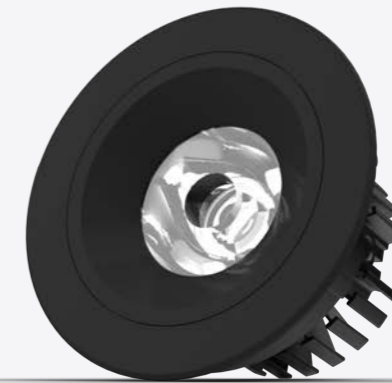

Description

The Dezzi Fixed Round is a high performance LED downlight, available with a large range of outputs, beam angles, colour rendering and accessory options. The entire Dezzi range has been designed around a replaceable modular concept to support use in the circular economy.

Features



Certification



Dimensions

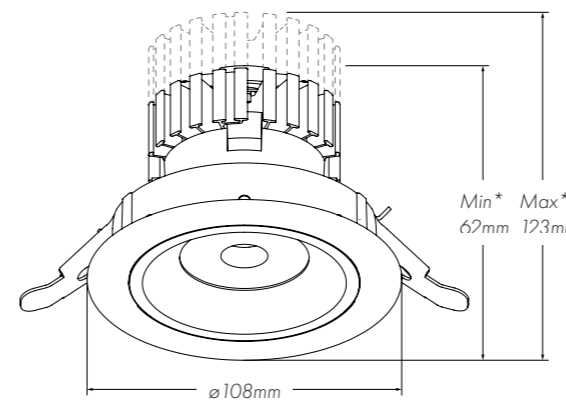

Product Builder

	Availability	XTM	XOB
Light Source			
(XT)	XTM	○	-
(XO)	XOB	-	○
Lumen Output			
(05)	500lm	○	○
(07)	700lm	○	○
(10)	1000lm	○	○
(13)	1300lm	○	○
(20)	2000lm	○	○
(30)	3000lm	○	○
Colour Temperature			
(22)	2200k	○	-
(27)	2700k	○	○
(30)	3000k	○	○
(35)	3500k	○	-
(40)	4000k	○	-
(56)	5600k	○	-
(DW)	Dim To Warm	-	-
(TW)	Tuneable	-	-
Colour Fidelity			
(80)	CR180+	○	-
(90)	CR190	○	○
(98)	CR198	○	-
(V9)	Vibrancy 98	○	-
(BT)	Beauty Series	○	-
Beam Angle			
(SL)	Spot Lens 10°	-	○
(2L)	Narrow Spot Lens 15°	○	○
(NL)	Narrow Lens 25°	○	○
(ML)	Medium Lens 35°	○	○
(WL)	Wide Lens 50°	○	○
(XL)	Extra Wide Lens 80°	○	○
(OL)	Ovals Lens	○	○
(NR)	Narrow Reflector 30°	-	○
(MR)	Medium Reflector 40°	○	○
(WR)	Wide Reflector 60°	○	○
(DS)	Dark Spot Lens 10°	-	○
(D2)	Dark Narrow Spot Lens 15°	○	○
(DN)	Dark Narrow Lens 25°	○	○
(DM)	Dark Medium Lens 45°	○	○
(DW)	Dark Wide Lens 55°	○	○
Trim Colour			
(W)	White	○	○
(B)	Black	○	○
(P)	Custom Colour	○	○
Bezel Colour			
(W)	White	○	○
(B)	Black	○	○
(P)	Custom Colour	○	○
Control			
/DD	DALI		
/DP	DALI Pro		
/DA	1-10v		
/AP	0.1-10v		
/PH	Phase		
/BC	BLE Casambi		
/DX	DMX		
/ND	No Driver		
Accessories			
/HL	Honeycomb Louvre		
/CG	Clear Lens		
/SL	Softening Lens		
/RG	Spread Lens		
/CF	20-40mm Ceiling Springs		
Emergency			
/M3	3 Hour Maintained		
/ST	Self Test		
/DE	DALI Emergency		
Key			
	Available	○	
	Not Available	-	

*based on output and beam angle, see spec sheets.

Light Source



Output

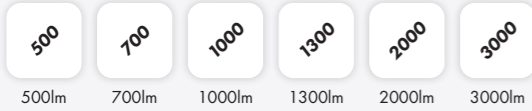

Colour Temperature

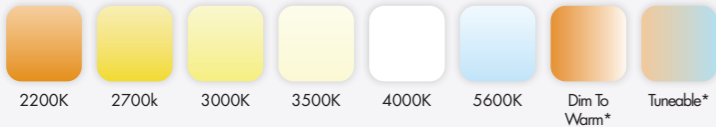

Colour Fidelity

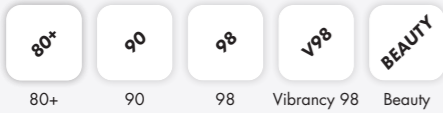

Beam Angle



Trim Colour

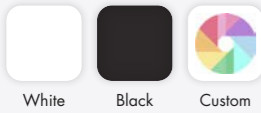

Bezel Colour

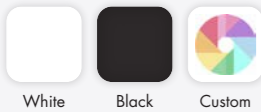

Accessories

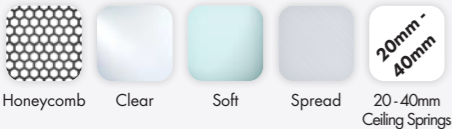

*available on request.

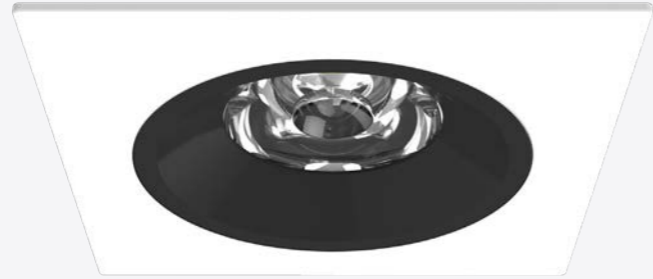

dezzi

DEZZI FIXED SQUARE

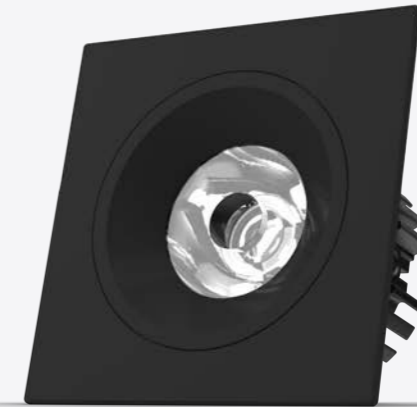

Description

The Dezzi Fixed Square is a high performance LED downlight, available with a large range of outputs, beam angles, colour rendering and accessory options. The entire Dezzi range has been designed around a replaceable modular concept to support use in the circular economy.

Features



Certification



Dimensions

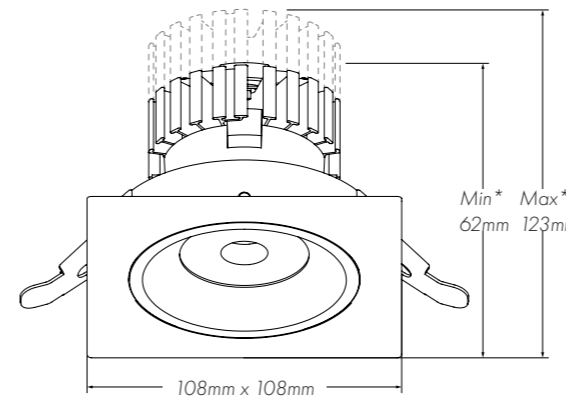

Product Builder

		Availability	XTM	XOB		
DFS	(XT)	Light Source	XTM	-		
	(XO)		XOB	-		
DFS	(05)	Lumen Output	500lm	○○		
	(07)		700lm	○○		
	(10)		1000lm	○○		
	(13)		1300lm	○○		
	(20)		2000lm	○○		
	(30)		3000lm	○○		
DFS	(22)	Colour Temperature	2200k	-		
	(27)		2700k	○○		
	(30)		3000k	○○		
	(35)		3500k	-		
	(40)		4000k	○○		
	(56)		5600k	-		
	(DW)		Dim To Warm	-		
(TW)		Tuneable	-			
DFS	(80)	Colour Fidelity	CRI80+	-		
	(90)		CRI90	○○		
	(98)		CRI98	-		
	(V9)		Vibrancy 98	○○		
DFS	(BT)		Beauty Series	-		
	(SL)	Beam Angle	Spot Lens 10°	-		
			Narrow Spot Lens 15°	○○		
			Narrow Lens 25°	○○		
			Medium Lens 35°	○○		
			Wide Lens 50°	○○		
			Extra Wide Lens 80°	○○		
			Ovals Lens	○○		
	(NR)	Narrow Reflector 30°	-			
	(MR)	Medium Reflector 40°	○○			
	(WR)	Wide Reflector 60°	○○			
	(DS)	Dark Spot Lens 10°	-			
	(D2)	Dark Narrow Spot Lens 15°	○○			
(DN)	Dark Narrow Lens 25°	○○				
(DM)	Dark Medium Lens 45°	○○				
(DW)	Dark Wide Lens 55°	○○				
DFS	Trim Colour	(W)	White	○○		
		(B)	Black	○○		
		(P)	Custom Colour	○○		
DFS	Bezel Colour	(W)	White	○○		
		(B)	Black	○○		
		(P)	Custom Colour	○○		
DFS	Control	/DD	DALI			
		/DP	DALI Pro			
		/DA	1-10v			
		/AP	0.1-10v			
		/PH	Phase			
		/BC	BLE Casambi			
		/DX	DMX			
		/ND	No Driver			
		DFS	Emergency	/M3	3 Hour Maintained	
				/ST	Self Test	
/DE	DALI Emergency					
DFS	Accessories	/HL	Honeycomb Louvre			
		/CG	Clear Lens			
		/SL	Softening Lens			
		/RG	Spread Lens			
		/CF	20-40mm Ceiling Springs			
		Key				
		Available	○			
		Not Available	-			

*based on output and beam angle, see spec sheets.

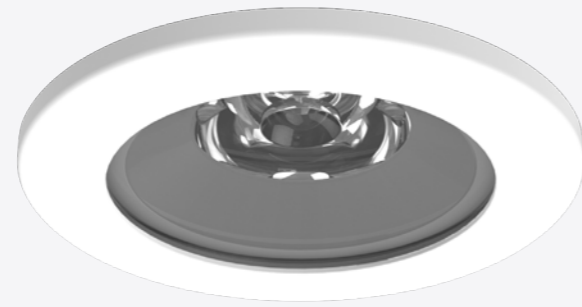

Light Source



Output

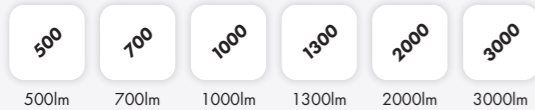

Colour Temperature

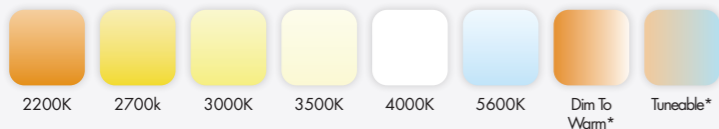

Colour Fidelity

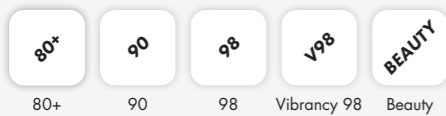

Beam Angle

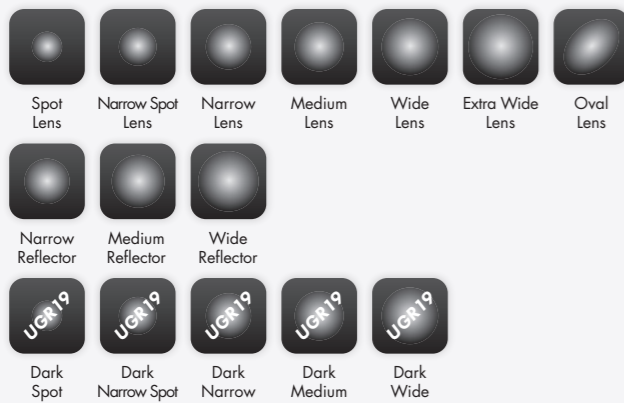

Trim Colour

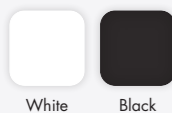

Bezel Colour

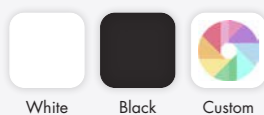

Accessories

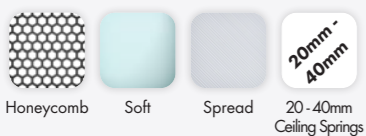

*available on request.

dezzi

DEZZI FIXED WET

↓ IP20

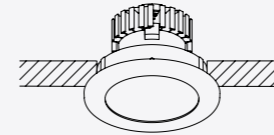

↑ IP65



Description

The Dezzi Fixed Wet is a high performance LED downlight, available with a large range of outputs, beam angles, colour rendering and accessory options. The luminaire is IP65 rated from the front. The entire Dezzi range has been designed around a replaceable modular concept to support use in the circular economy.

Features



Certification



Dimensions

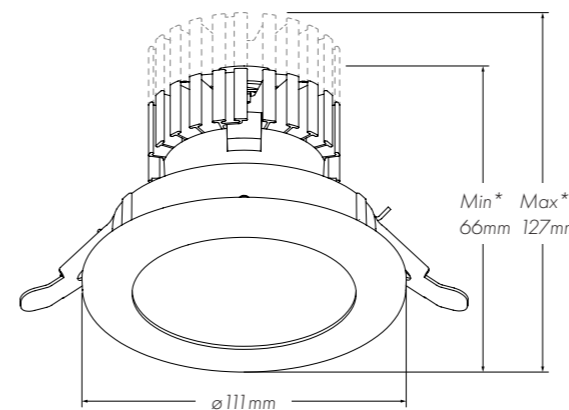

Product Builder

	Availability	XTM	XOB
Light Source			
(XT)	XTM	○	-
(XO)	XOB	-	○
Lumen Output			
(05)	500lm	○	○
(07)	700lm	○	○
(10)	1000lm	○	○
(13)	1300lm	○	○
(20)	2000lm	○	○
(30)	3000lm	○	○
Colour Temperature			
(22)	2200k	○	-
(27)	2700k	○	○
(30)	3000k	○	○
(35)	3500k	○	-
(40)	4000k	○	○
(56)	5600k	○	-
(DW)	Dim To Warm	-	-
(TW)	Tuneable	-	-
Colour Fidelity			
(80)	CR180+	○	-
(90)	CR190	○	○
(98)	CR198	○	-
(V9)	Vibrancy 98	○	-
(BT)	Beauty Series	○	-
Beam Angle			
(SL)	Spot Lens 10°	-	○
(2L)	Narrow Spot Lens 15°	○	○
(NL)	Narrow Lens 25°	○	○
(ML)	Medium Lens 35°	○	○
(WL)	Wide Lens 50°	○	○
(XL)	Extra Wide Lens 80°	○	○
(OL)	Ovals Lens	○	○
(NR)	Narrow Reflector 30°	-	○
(MR)	Medium Reflector 40°	○	○
(WR)	Wide Reflector 60°	○	○
(DS)	Dark Spot Lens 10°	-	○
(D2)	Dark Narrow Spot Lens 15°	○	○
(DN)	Dark Narrow Lens 25°	○	○
(DM)	Dark Medium Lens 45°	○	○
(DW)	Dark Wide Lens 55°	○	○
Trim Colour			
(W)	White	○	○
(B)	Black	○	○
Bezel Colour			
(W)	White	○	○
(B)	Black	○	○
(PI)	Custom Colour	○	○
Control			
/DD	DALI		
/DP	DALI Pro		
/DA	1-10v		
/AP	0,1-10v		
/PH	Phase		
/BC	BLE Casambi		
/DX	DMX		
/ND	No Driver		
Emergency			
/M3	3 Hour Maintained		
/ST	Self Test		
/DE	DALI Emergency		
Accessories			
/HL	Honeycomb Louvre		
/SL	Softening Lens		
/RG	Spread Lens		
/CF	20-40mm Ceiling Springs		
Key			
Available	○		
Not Available	-		

*based on output and beam angle, see spec sheets.

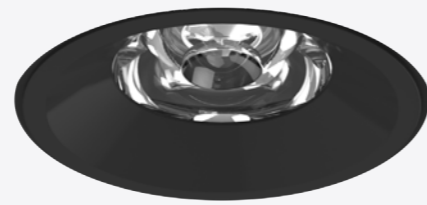

Light Source



Output

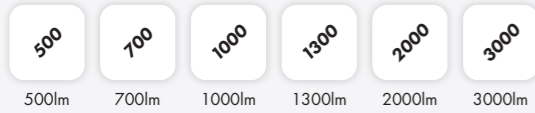

Colour Temperature

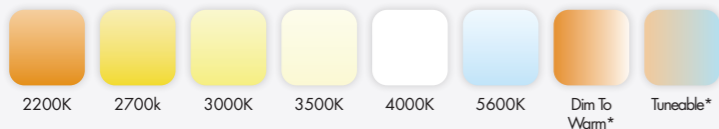

Colour Fidelity

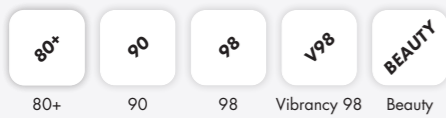

Beam Angle

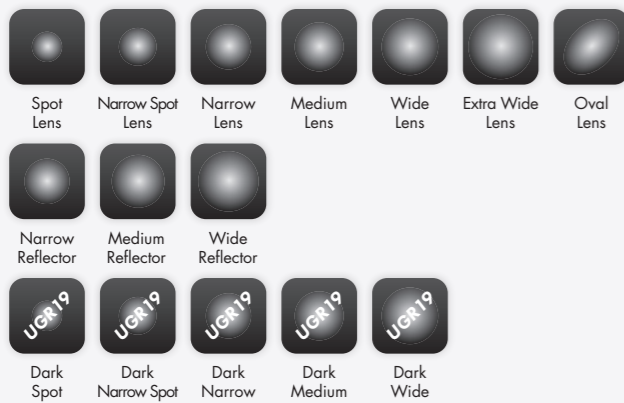

Trim Colour



Bezel Colour

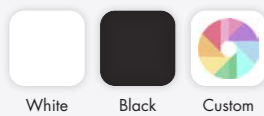

Accessories

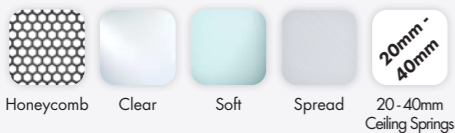

*available on request.

dezzi

DEZZI FIXED TRIMLESS



Description

The Dezzi Fixed Trimless is a high performance LED downlight, available with a large range of outputs, beam angles, colour rendering and accessory options. The luminaire once installed provides a seamless look to any installation. The entire Dezzi range has been designed around a replaceable modular concept to support use in the circular economy.

Features



Certification



Dimensions

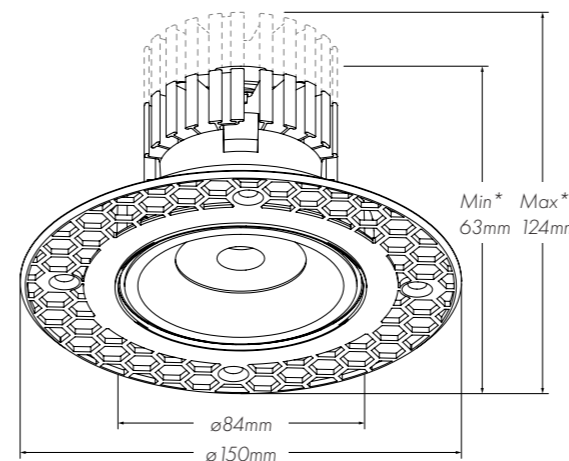

Product Builder

	Availability	XTM	XOB
Light Source			
(XT)	XTM	<input type="checkbox"/>	<input type="checkbox"/>
(XO)	XOB	<input type="checkbox"/>	<input type="checkbox"/>
Lumen Output			
(05)	500lm	<input type="checkbox"/>	<input type="checkbox"/>
(07)	700lm	<input type="checkbox"/>	<input type="checkbox"/>
(10)	1000lm	<input type="checkbox"/>	<input type="checkbox"/>
(13)	1300lm	<input type="checkbox"/>	<input type="checkbox"/>
(20)	2000lm	<input type="checkbox"/>	<input type="checkbox"/>
(30)	3000lm	<input type="checkbox"/>	<input type="checkbox"/>
Colour Temperature			
(22)	2200k	<input type="checkbox"/>	<input type="checkbox"/>
(27)	2700k	<input type="checkbox"/>	<input type="checkbox"/>
(30)	3000k	<input type="checkbox"/>	<input type="checkbox"/>
(35)	3500k	<input type="checkbox"/>	<input type="checkbox"/>
(40)	4000k	<input type="checkbox"/>	<input type="checkbox"/>
(56)	5600k	<input type="checkbox"/>	<input type="checkbox"/>
(DW)	Dim To Warm	<input type="checkbox"/>	<input type="checkbox"/>
(TW)	Tuneable	<input type="checkbox"/>	<input type="checkbox"/>
Colour Fidelity			
(80)	CR180+	<input type="checkbox"/>	<input type="checkbox"/>
(90)	CR190	<input type="checkbox"/>	<input type="checkbox"/>
(98)	CR198	<input type="checkbox"/>	<input type="checkbox"/>
(V9)	Vibrancy 98	<input type="checkbox"/>	<input type="checkbox"/>
(BT)	Beauty Series	<input type="checkbox"/>	<input type="checkbox"/>
Beam Angle			
(SL)	Spot Lens 10°	<input type="checkbox"/>	<input type="checkbox"/>
(2L)	Narrow Spot Lens 15°	<input type="checkbox"/>	<input type="checkbox"/>
(NL)	Narrow Lens 25°	<input type="checkbox"/>	<input type="checkbox"/>
(ML)	Medium Lens 35°	<input type="checkbox"/>	<input type="checkbox"/>
(WL)	Wide Lens 50°	<input type="checkbox"/>	<input type="checkbox"/>
(XL)	Extra Wide Lens 80°	<input type="checkbox"/>	<input type="checkbox"/>
(OL)	Ovals Lens	<input type="checkbox"/>	<input type="checkbox"/>
(NR)	Narrow Reflector 30°	<input type="checkbox"/>	<input type="checkbox"/>
(MR)	Medium Reflector 40°	<input type="checkbox"/>	<input type="checkbox"/>
(WR)	Wide Reflector 60°	<input type="checkbox"/>	<input type="checkbox"/>
(DS)	Dark Spot Lens 10°	<input type="checkbox"/>	<input type="checkbox"/>
(D2)	Dark Narrow Spot Lens 15°	<input type="checkbox"/>	<input type="checkbox"/>
(DN)	Dark Narrow Lens 25°	<input type="checkbox"/>	<input type="checkbox"/>
(DM)	Dark Medium Lens 45°	<input type="checkbox"/>	<input type="checkbox"/>
(DW)	Dark Wide Lens 55°	<input type="checkbox"/>	<input type="checkbox"/>
Trim Colour			
(X)	Trimless	<input type="checkbox"/>	<input type="checkbox"/>
Bezel Colour			
(W)	White	<input type="checkbox"/>	<input type="checkbox"/>
(B)	Black	<input type="checkbox"/>	<input type="checkbox"/>
(PI)	Custom Colour	<input type="checkbox"/>	<input type="checkbox"/>
DFT			
	/**/**		
Control			
/DD	DALI		
/DP	DALI Pro		
/DA	1-10v		
/AP	0,1-10v		
/PH	Phase		
/BC	BLE Casambi		
/DX	DMX		
/ND	No Driver		
Emergency			
/M3	3 Hour Maintained		
/ST	Self Test		
/DE	DALI Emergency		
Accessories			
/HL	Honeycomb Louvre		
/CG	Clear Lens		
/SL	Softening Lens		
/RG	Spread Lens		
/CF	20-40mm Ceiling Springs		
Key			
	Available	<input type="checkbox"/>	
	Not Available	<input type="checkbox"/>	

*based on output and beam angle, see spec sheets.



Light Source



Output

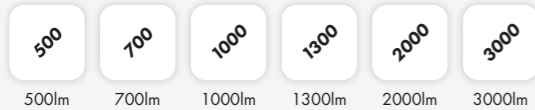

Colour Temperature

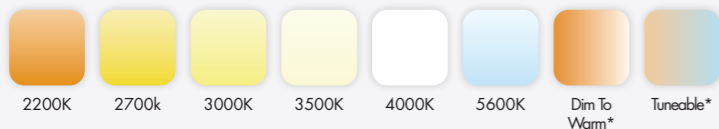

Colour Fidelity

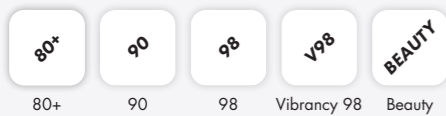

Beam Angle

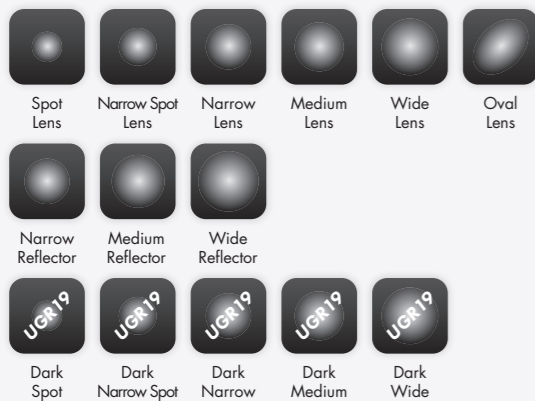

Trim Colour

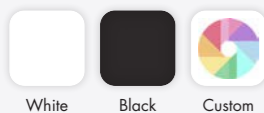

Bezel Colour

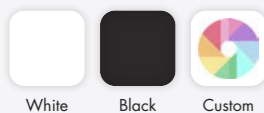

Accessories

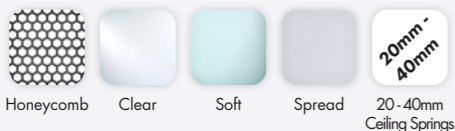

*available on request.

dezzi

DEZZI ADJUSTABLE ROUND



Description

The Dezzi Adjustable Round is a high performance LED downlight, available with a large range of outputs, beam angles, colour rendering and accessory options. The luminaire is fully adjustable with 40° of tilt and 360° of rotation. The entire Dezzi range has been designed around a replaceable modular concept to support use in the circular economy.

Features



Certification



Dimensions

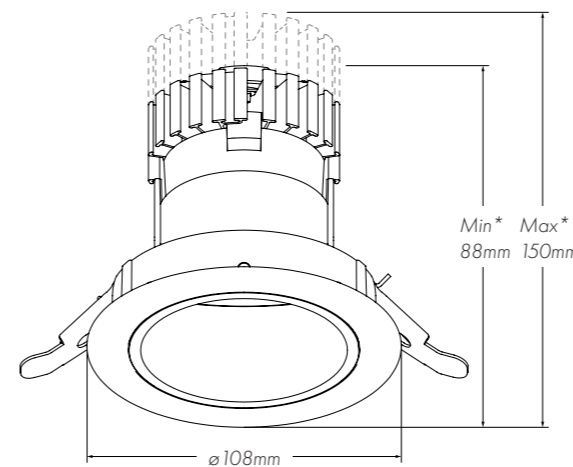

Product Builder

	Availability	XTM	XOB
Light Source			
(XT)	XTM	○	-
(XO)	XOB	-	○
Lumen Output			
(05)	500lm	○	○
(07)	700lm	○	○
(10)	1000lm	○	○
(13)	1300lm	○	○
(20)	2000lm	○	○
(30)	3000lm	○	○
Colour Temperature			
(22)	2200k	○	-
(27)	2700k	○	○
(30)	3000k	○	○
(35)	3500k	○	-
(40)	4000k	○	○
(56)	5600k	○	-
(DW)	Dim To Warm	-	-
(TW)	Tuneable	-	-
Colour Fidelity			
(80)	CR180+	○	-
(90)	CR190	○	○
(98)	CR198	○	-
(V9)	Vibrancy 98	○	-
(BT)	Beauty Series	○	-
Beam Angle			
(SL)	Spot Lens 10°	-	○
(2L)	Narrow Spot Lens 15°	○	○
(NL)	Narrow Lens 25°	○	○
(ML)	Medium Lens 35°	○	○
(WL)	Wide Lens 50°	○	○
(OL)	Ovals Lens	○	○
(NR)	Narrow Reflector 30°	-	○
(MR)	Medium Reflector 40°	○	○
(WR)	Wide Reflector 60°	○	○
(DS)	Dark Spot Lens 10°	-	○
(D2)	Dark Narrow Spot Lens 15°	○	○
(DN)	Dark Narrow Lens 25°	○	○
(DM)	Dark Medium Lens 45°	○	○
(DW)	Dark Wide Lens 55°	○	○
Trim Colour			
(W)	White	○	○
(B)	Black	○	○
(P)	Custom Colour	○	○
Bezel Colour			
(W)	White	○	○
(B)	Black	○	○
(PI)	Custom Colour	○	○
Control			
/DD	DALI		
/DP	DALI Pro		
/DA	1-10v		
/AP	0, 1-10v		
/PH	Phase		
/BC	BLE Casambi		
/DX	DMX		
/ND	No Driver		
Emergency			
/M3	3 Hour Maintained		
/ST	Self Test		
/DE	DALI Emergency		
Accessories			
/HL	Honeycomb Louvre		
/CG	Clear Lens		
/SL	Softening Lens		
/RG	Spread Lens		
/CF	20-40mm Ceiling Springs		
Key			
Available	○		
Not Available	-		

*based on output and beam angle, see spec sheets.



Light Source



Output

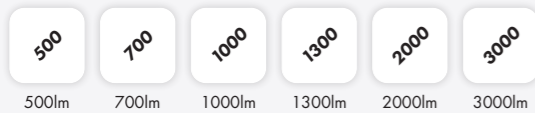

Colour Temperature

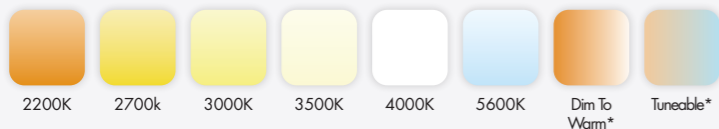

Colour Fidelity

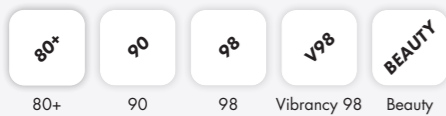

Beam Angle

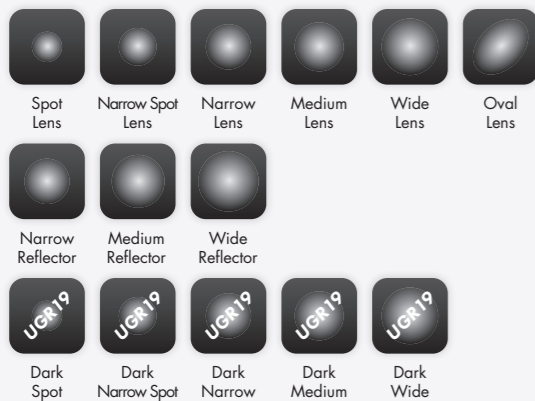

Trim Colour

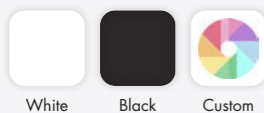

Bezel Colour

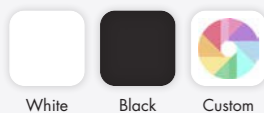

Accessories

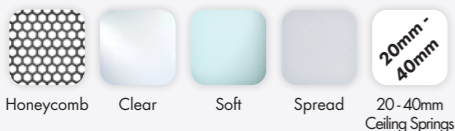

*available on request.

dezzi

DEZZI ADJUSTABLE SQUARE

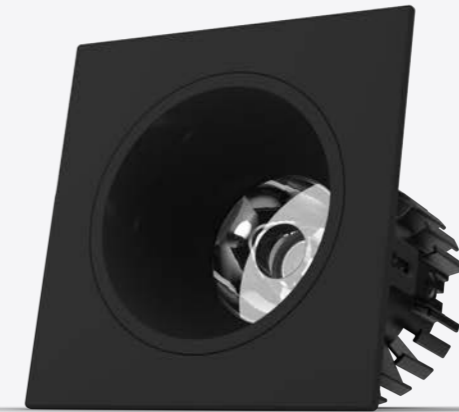

Description

The Dezzi Adjustable Square is a high performance LED downlight, available with a large range of outputs, beam angles, colour rendering and accessory options. The luminaire is fully adjustable with 40° of tilt and 360° of rotation. The entire Dezzi range has been designed around a replaceable modular concept to support use in the circular economy.

Features



Certification



Dimensions

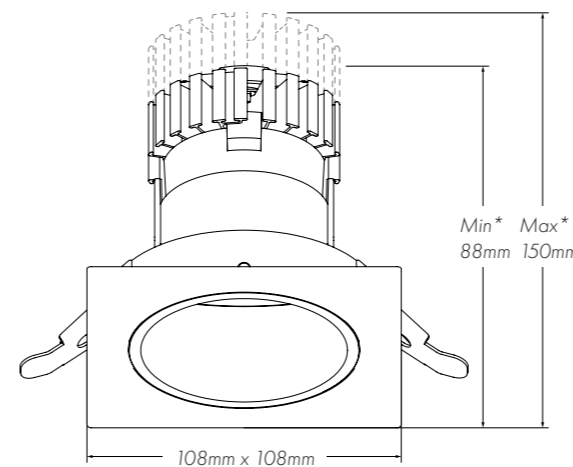

Product Builder

	Availability	XTM	XOB
Light Source			
(XT)	XTM	-	-
(XO)	XOB	-	-
Lumen Output			
(05)	500lm	○	○
(07)	700lm	○	○
(10)	1000lm	○	○
(13)	1300lm	○	○
(20)	2000lm	○	○
(30)	3000lm	○	○
Colour Temperature			
(22)	2200k	-	-
(27)	2700k	○	○
(30)	3000k	○	○
(35)	3500k	-	-
(40)	4000k	○	○
(56)	5600k	-	-
(DW)	Dim To Warm	-	-
(TW)	Tuneable	-	-
Colour Fidelity			
(80)	CR180+	-	-
(90)	CR190	○	○
(98)	CR198	-	-
(V9)	Vibrancy 98	○	○
(BT)	Beauty Series	-	-
Beam Angle			
(SL)	Spot Lens 10°	-	○
(2L)	Narrow Spot Lens 15°	○	○
(NL)	Narrow Lens 25°	○	○
(ML)	Medium Lens 35°	○	○
(WL)	Wide Lens 50°	○	○
(OL)	Ovals Lens	○	○
(NR)	Narrow Reflector 30°	-	-
(MR)	Medium Reflector 40°	○	○
(WR)	Wide Reflector 60°	○	○
(DS)	Dark Spot Lens 10°	-	-
(D2)	Dark Narrow Spot Lens 15°	○	○
(DN)	Dark Narrow Lens 25°	○	○
(DM)	Dark Medium Lens 45°	○	○
(DW)	Dark Wide Lens 55°	○	○
Trim Colour			
(W)	White	○	○
(B)	Black	○	○
(P)	Custom Colour	○	○
Bezel Colour			
(W)	White	○	○
(B)	Black	○	○
(PI)	Custom Colour	○	○
DAS	Control	Accessories	
	/DD DALI	/HL Honeycomb Louvre	
	/DP DALI Pro	/CG Clear Lens	
	/DA 1-10v	/SL Softening Lens	
	/AP 0,1-10v	/RG Spread Lens	
	/PH Phase	/CF 20-40mm Ceiling Springs	
	/BC BLE Casambi		
	/DX DMX		
	/ND No Driver		
	Emergency		
	/M3 3 Hour Maintained		
	/ST Self Test		
	/DE DALI Emergency		
		Key	
		Available	○
		Not Available	-

*based on output and beam angle, see spec sheets.

Light Source



Output

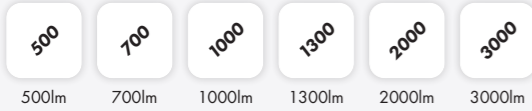

Colour Temperature

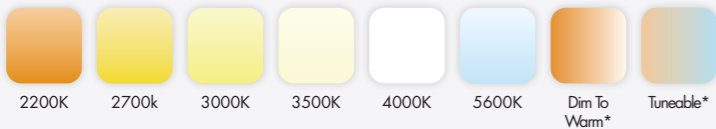

Colour Fidelity

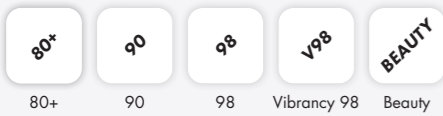

Beam Angle

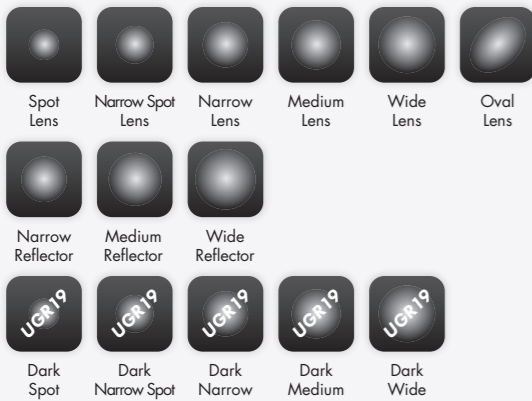

Trim Colour

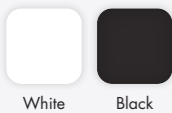

Bezel Colour

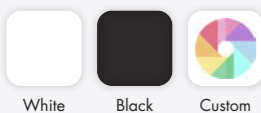

Accessories

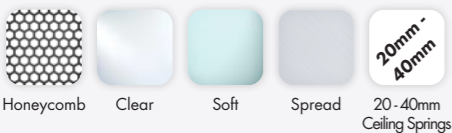

*available on request.



dezzi

DEZZI ADJUSTABLE WET

↓ IP20

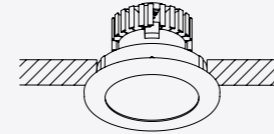

↑ IP65

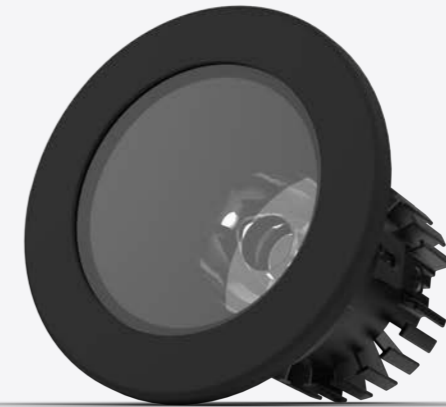

Description

The Dezzi Adjustable Wet is a high performance LED downlight, available with a large range of outputs, beam angles, colour rendering and accessory options. The luminaire is fully adjustable with 40° of tilt and 360° of rotation, with an IP65 rating from the front. The entire Dezzi range has been designed around a replaceable modular concept to support use in the circular economy.

Features



Certification



Dimensions

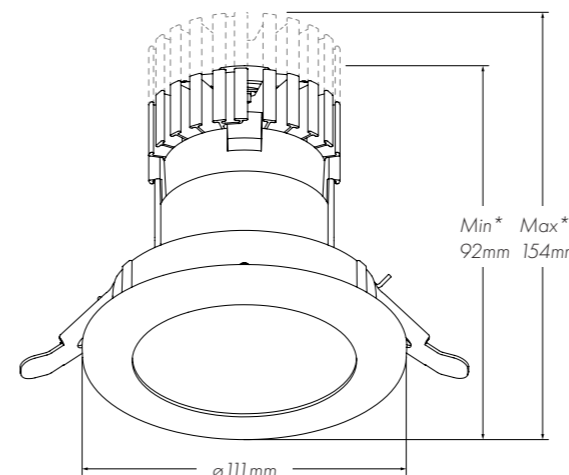

Product Builder

	Availability	XTM	XOB
Light Source			
(XT)	XTM	○	-
(XO)	XOB	-	○
Lumen Output			
(05)	500lm	○	○
(07)	700lm	○	○
(10)	1000lm	○	○
(13)	1300lm	○	○
(20)	2000lm	○	○
(30)	3000lm	○	○
Colour Temperature			
(22)	2200k	○	-
(27)	2700k	○	○
(30)	3000k	○	○
(35)	3500k	○	-
(40)	4000k	○	○
(56)	5600k	○	-
(DW)	Dim To Warm	-	-
(TW)	Tuneable	-	-
Colour Fidelity			
(80)	CR180+	○	-
(90)	CR190	○	○
(98)	CR198	○	-
(V9)	Vibrancy 98	○	-
(BT)	Beauty Series	○	-
Beam Angle			
(SL)	Spot Lens 10°	-	○
(2L)	Narrow Spot Lens 15°	○	○
(NL)	Narrow Lens 25°	○	○
(ML)	Medium Lens 35°	○	○
(WL)	Wide Lens 50°	○	○
(OL)	Ovals Lens	○	○
(NR)	Narrow Reflector 30°	-	○
(MR)	Medium Reflector 40°	○	○
(WR)	Wide Reflector 60°	○	○
(DS)	Dark Spot Lens 10°	-	○
(D2)	Dark Narrow Spot Lens 15°	○	○
(DN)	Dark Narrow Lens 25°	○	○
(DM)	Dark Medium Lens 45°	○	○
(DW)	Dark Wide Lens 55°	○	○
Trim Colour			
(W)	White	○	○
(B)	Black	○	○
Bezel Colour			
(WI)	White	○	○
(BI)	Black	○	○
(PI)	Custom Colour	○	○
Control			
/DD	DALI		
/DP	DALI Pro		
/DA	1-10v		
/AP	0,1-10v		
/PH	Phase		
/BC	BLE Casambi		
/DX	DMX		
/ND	No Driver		
Accessories			
/HL	Honeycomb Louvre		
/CG	Clear Lens		
/SL	Softening Lens		
/RG	Spread Lens		
/CF	20-40mm Ceiling Springs		
Emergency			
/M3	3 Hour Maintained		
/ST	Self Test		
/DE	DALI Emergency		
Key			
Available	○		
Not Available	-		

*based on output and beam angle, see spec sheets.



Light Source



Output

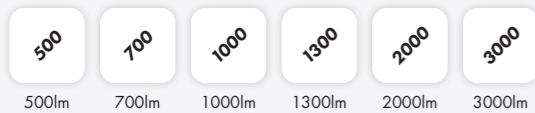

Colour Temperature

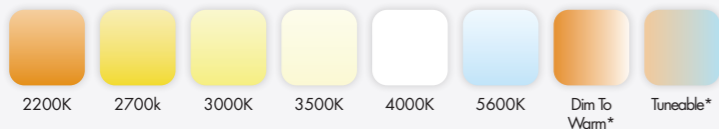

Colour Fidelity

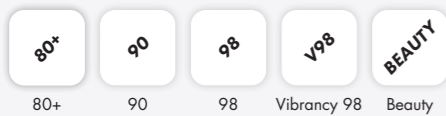

Beam Angle



Trim Colour



Bezel Colour

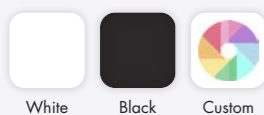

Accessories

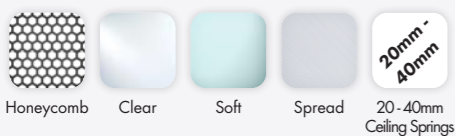

*available on request.

dezzi

DEZZI ADJUSTABLE TRIMLESS



Description

The Dezzi Adjustable Trimless is a high performance LED downlight, available with a large range of outputs, beam angles, colour rendering and accessory options. The luminaire is fully adjustable with 40° of tilt and 360° of rotation, once it installed provides a seamless look to any installation. The entire Dezzi range has been designed around a replaceable modular concept to support use in the circular economy.

Features



Certification



Dimensions

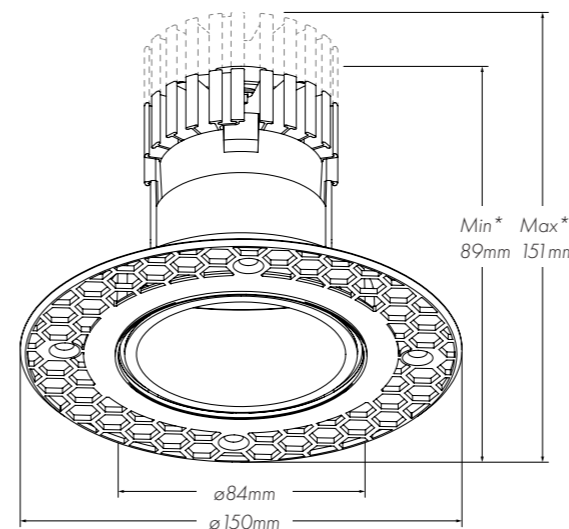

Product Builder

	Availability	XTM	XOB
Light Source			
(XT)	XTM	○	-
(XO)	XOB	-	○
Lumen Output			
(05)	500lm	○	○
(07)	700lm	○	○
(10)	1000lm	○	○
(13)	1300lm	○	○
(20)	2000lm	○	○
(30)	3000lm	○	○
Colour Temperature			
(22)	2200k	○	-
(27)	2700k	○	○
(30)	3000k	○	○
(35)	3500k	○	-
(40)	4000k	○	○
(56)	5600k	○	-
(DW)	Dim To Warm	-	-
(TW)	Tuneable	-	-
Colour Fidelity			
(80)	CR180+	○	-
(90)	CR190	○	○
(98)	CR198	○	-
(V9)	Vibrancy 98	○	-
(BT)	Beauty Series	○	-
Beam Angle			
(SL)	Spot Lens 10°	-	○
(2L)	Narrow Spot Lens 15°	○	○
(NL)	Narrow Lens 25°	○	○
(ML)	Medium Lens 35°	○	○
(WL)	Wide Lens 50°	○	○
(OL)	Ovals Lens	○	○
(NR)	Narrow Reflector 30°	-	○
(MR)	Medium Reflector 40°	○	○
(WR)	Wide Reflector 60°	○	○
(DS)	Dark Spot Lens 10°	-	○
(D2)	Dark Narrow Spot Lens 15°	○	○
(DN)	Dark Narrow Lens 25°	○	○
(DM)	Dark Medium Lens 45°	○	○
(DW)	Dark Wide Lens 55°	○	○
Trim Colour			
(X)	Trimless	○	○
Bezel Colour			
(W)	White	○	○
(B)	Black	○	○
(PI)	Custom Colour	○	○
Control			
/DD	DALI		
/DP	DALI Pro		
/DA	1-10v		
/AP	0.1-10v		
/PH	Phase		
/BC	BLE Casambi		
/DX	DMX		
/ND	No Driver		
Accessories			
/HL	Honeycomb Louvre		
/CG	Clear Lens		
/SL	Softening Lens		
/RG	Spread Lens		
/CF	20-40mm Ceiling Springs		
Emergency			
/M3	3 Hour Maintained		
/ST	Self Test		
/DE	DALI Emergency		
Key			
Available	○		
Not Available	-		

*based on output and beam angle, see spec sheets.



Light Source



Output

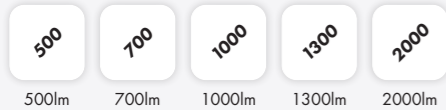

Colour Temperature

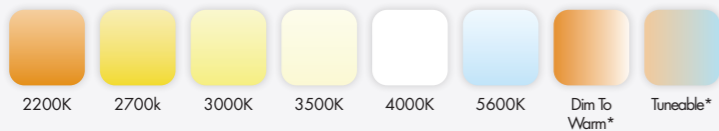

Colour Fidelity

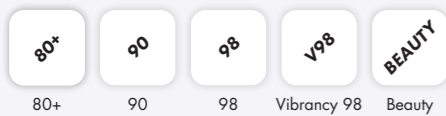

Beam Angle



Trim Colour

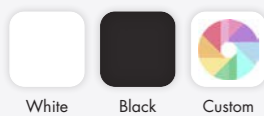

Bezel Colour

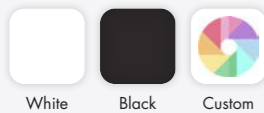

Accessories



20-40mm Ceiling Springs

*available on request.

dezzi

DEZZI WALLWASH ROUND

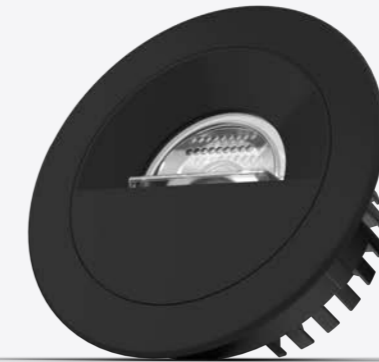

Description

The Dezzi Wallwash Round is a high performance LED downlight, available with a large range of outputs, beam angles, colour rendering and accessory options. The luminaire has 360° of rotation. The entire Dezzi range has been designed around a replaceable modular concept to support use in the circular economy.

Features



Certification



Dimensions

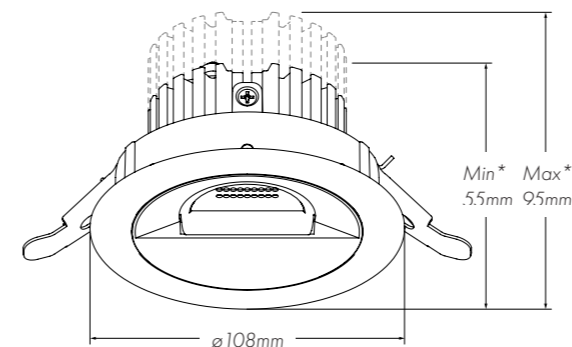

Product Builder

		Availability	XTM	XOB
Light Source	(XT)	XTM	○	-
	(XO)	XOB	-	○
Lumen Output	(05)	500lm	○	○
	(07)	700lm	○	○
	(10)	1000lm	○	○
	(13)	1300lm	○	○
	(20)	2000lm	○	○
Colour Temperature	(22)	2200k	○	-
	(27)	2700k	○	○
	(30)	3000k	○	○
	(35)	3500k	○	-
	(40)	4000k	○	○
	(56)	5600k	○	-
	(DW)	Dim To Warm	-	-
(TW)	Tuneable	-	-	
Colour Fidelity	(80)	CR180+	○	-
	(90)	CR190	○	○
	(98)	CR198	○	-
	(V9)	Vibrancy 98	○	-
	(BT)	Beauty Series	○	-
Beam Angle	(AW)	Asymmetric	○	○
	(DW)	Double Asymmetric	○	○
Trim Colour	(W)	White	○	○
	(B)	Black	○	○
	(P)	Custom Colour	○	○
Bezel Colour	(W)	White	○	○
	(B)	Black	○	○
	(P)	Custom Colour	○	○
Control	/DD	DALI		
	/DP	DALI Pro		
Emergency	/DA	1-10v		
	/AP	0.1-10v		
	/PH	Phase		
	/BC	BLE Casambi		
	/DX	DMX		
	/ND	No Driver		
	/M3	3 Hour Maintained		
/ST	Self Test			
/DE	DALI Emergency			
Accessories	/CF	20-40mm Ceiling Springs		
Key		Available	○	
		Not Available	-	

*based on output and beam angle, see spec sheets.

Light Source



Output



Colour Temperature

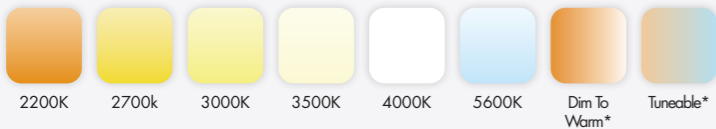

Colour Fidelity

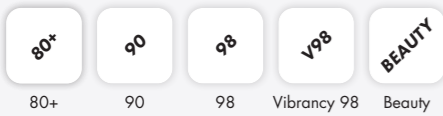

Beam Angle



Trim Colour

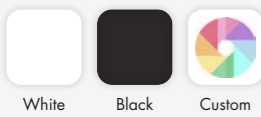

Bezel Colour

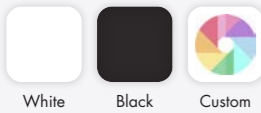

Accessories



20-40mm Ceiling Springs

*available on request.



dezzi

DEZZI WALLWASH SQUARE

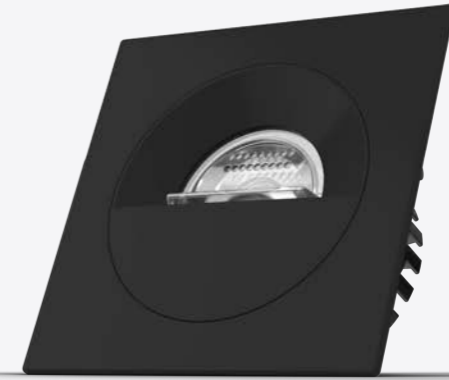

Description

The Dezzi Wallwash Square is a high performance LED downlight, available with a large range of outputs, beam angles, colour rendering and accessory options. The luminaire has 360° of rotation. The entire Dezzi range has been designed around a replaceable modular concept to support use in the circular economy.

Features



Certification



Dimensions

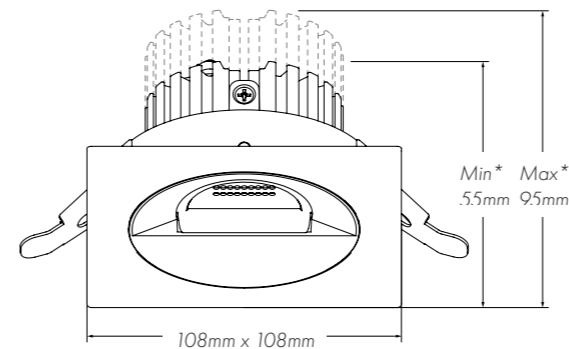

Product Builder

	Availability	XTM	XOB
Light Source			
(XT)	XTM	○	-
(XO)	XOB	-	○
Lumen Output			
(05)	500lm	○	○
(07)	700lm	○	○
(10)	1000lm	○	○
(13)	1300lm	○	○
(20)	2000lm	○	○
Colour Temperature			
(22)	2200k	○	-
(27)	2700k	○	○
(30)	3000k	○	○
(35)	3500k	○	-
(40)	4000k	○	○
(56)	5600k	○	-
(DW)	Dim To Warm	-	-
(TW)	Tuneable	-	-
Colour Fidelity			
(80)	CR180+	○	-
(90)	CR190	○	○
(98)	CR198	○	-
(V9)	Vibrancy 98	○	-
(BT)	Beauty Series	○	-
Beam Angle			
(AW)	Asymmetric	○	○
(DW)	Double Asymmetric	○	○
Trim Colour			
(W)	White	○	○
(B)	Black	○	○
(P)	Custom Colour	○	○
Bezel Colour			
(W)	White	○	○
(B)	Black	○	○
(P)	Custom Colour	○	○
Control			
/DD	DALI		
/DP	DALI Pro		
/DA	1-10v		
/AP	0.1-10v		
/PH	Phase		
/BC	BLE Casambi		
/DX	DMX		
/ND	No Driver		
Emergency			
/M3	3 Hour Maintained		
/ST	Self Test		
/DE	DALI Emergency		
Accessories			
/CF	20-40mm Ceiling Springs		
Key			
	Available	○	
	Not Available	-	

*based on output and beam angle, see spec sheets.

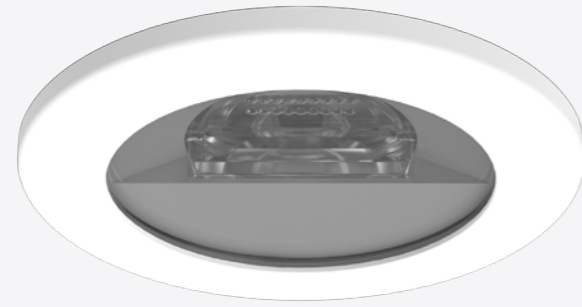

Light Source



Output

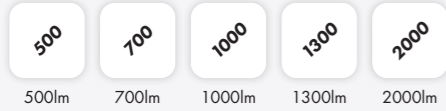

Colour Temperature

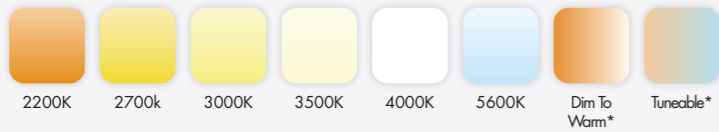

Colour Fidelity

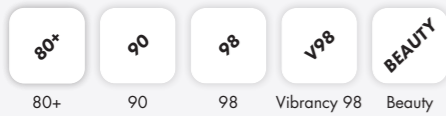

Beam Angle

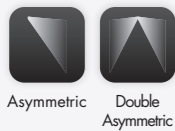

Trim Colour

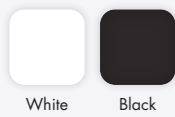

Bezel Colour

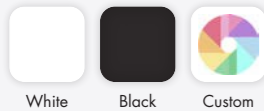

Accessories



20-40mm Ceiling Springs

*available on request.

dezzi

DEZZI WALLWASH WET

↓ IP20

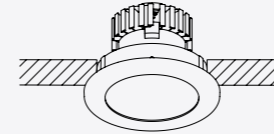

↑ IP65

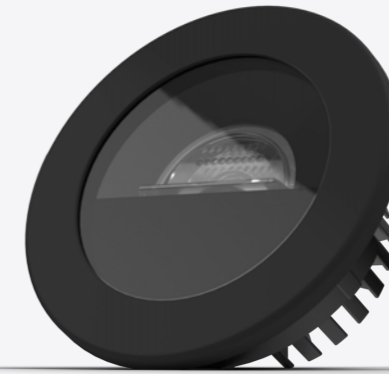

Description

The Dezzi Wallwash Wet is a high performance LED downlight, available with a large range of outputs, beam angles, colour rendering and accessory options. The luminaire has 360° of rotation and is IP65 rated from the front. The entire Dezzi range has been designed around a replaceable modular concept to support use in the circular economy.

Features



Certification



Dimensions

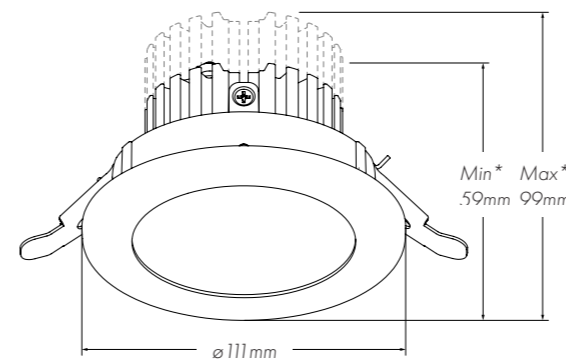

Product Builder

	Availability	XTM	XOB
Light Source			
(XT)	XTM	○	-
(XO)	XOB	-	○
Lumen Output			
(05)	500lm	○	○
(07)	700lm	○	○
(10)	1000lm	○	○
(13)	1300lm	○	○
(20)	2000lm	○	○
Colour Temperature			
(22)	2200k	○	-
(27)	2700k	○	○
(30)	3000k	○	○
(35)	3500k	○	-
(40)	4000k	○	○
(56)	5600k	○	-
(DW)	Dim To Warm	-	-
(TW)	Tuneable	-	-
Colour Fidelity			
(80)	CR180+	○	-
(90)	CR190	○	○
(98)	CR198	○	-
(V9)	Vibrancy 98	○	-
(BT)	Beauty Series	○	-
Beam Angle			
(AW)	Asymmetric	○	○
(DW)	Double Asymmetric	○	○
Trim Colour			
(W)	White	○	○
(B)	Black	○	○
Bezel Colour			
(W)	White	○	○
(B)	Black	○	○
(PI)	Custom Colour	○	○
Control			
/DD	DALI		
/DP	DALI Pro		
/DA	1-10v		
/AP	0.1-10v		
/PH	Phase		
/BC	BLE Casambi		
/DX	DMX		
/ND	No Driver		
Emergency			
/M3	3 Hour Maintained		
/ST	Self Test		
/DE	DALI Emergency		
Accessories			
/CF	20-40mm Ceiling Springs		
Key			
	Available	○	
	Not Available	-	

*based on output and beam angle, see spec sheets.



Light Source



Output

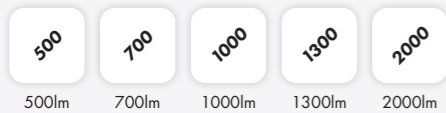

Colour Temperature

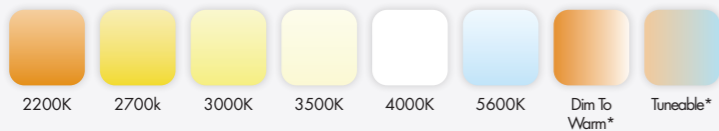

Colour Fidelity

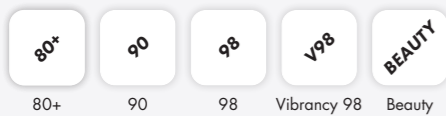

Beam Angle



Trim Colour



Bezel Colour

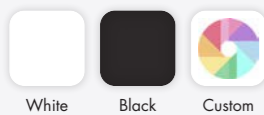

Accessories



20-40mm Ceiling Springs

*available on request.

dezzi

DEZZI WALLWASH TRIMLESS

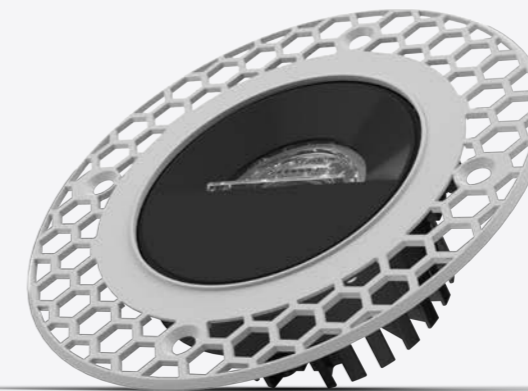

Description

The Dezzi Wallwash Trimless is a high performance LED downlight, available with a large range of outputs, beam angles, colour rendering and accessory options. The luminaire has 360° of rotation and once installed offers a seamless look. The entire Dezzi range has been designed around a replaceable modular concept to support use in the circular economy.

Features



Certification



Dimensions

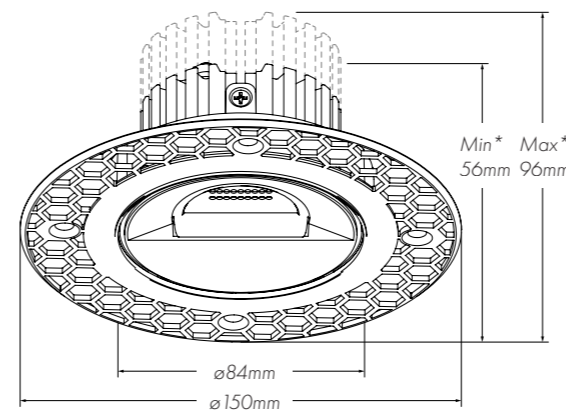

Product Builder

		Availability	XTM	XOB
Light Source	(XT)	XTM	○	-
	(XO)	XOB	-	○
Lumen Output	(05)	500lm	○	○
	(07)	700lm	○	○
	(10)	1000lm	○	○
	(13)	1300lm	○	○
	(20)	2000lm	○	○
Colour Temperature	(22)	2200k	○	-
	(27)	2700k	○	○
	(30)	3000k	○	○
	(35)	3500k	○	-
	(40)	4000k	○	○
	(56)	5600k	○	-
	(DW)	Dim To Warm	-	-
(TW)	Tuneable	-	-	
Colour Fidelity	(80)	CR180+	○	-
	(90)	CR190	○	○
	(98)	CR198	○	-
	(V9)	Vibrancy 98	○	-
	(BT)	Beauty Series	○	-
Beam Angle	(AW)	Asymmetric	○	○
	(DW)	Double Asymmetric	○	○
Trim Colour	(X)	Trimless	○	○
Bezel Colour	(WI)	White	○	○
	(BI)	Black	○	○
	(PI)	Custom Colour	○	○
Control	/DD	DALI		
	/DP	DALI Pro		
	/DA	1-10v		
	/AP	0.1-10v		
	/PH	Phase		
	/BC	BLE Casambi		
/DX	DMX			
/ND	No Driver			
Emergency	/M3	3 Hour Maintained		
	/ST	Self Test		
	/DE	DALI Emergency		
Accessories	/CF	20-40mm Ceiling Springs		
		Key	Available	○
			Not Available	-

*based on output and beam angle, see spec sheets.



Light Source



Output

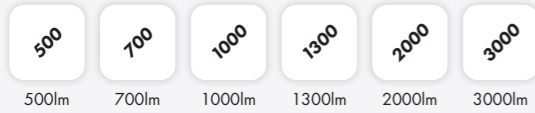

Colour Temperature

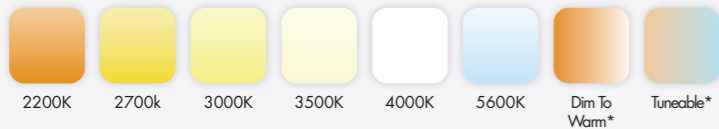

Colour Fidelity

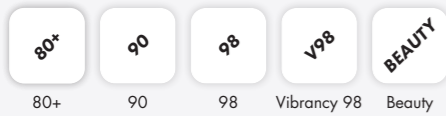

Beam Angle



Trim Colour

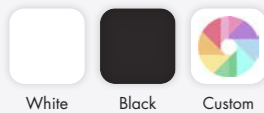

Bezel Colour

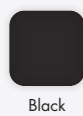

Accessories

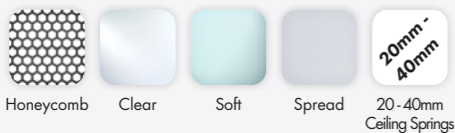

*available on request.

dezzi

DEZZI PIN HOLE ROUND



Description

The Dezzi Pin Hole Round is a high performance LED downlight, available with a large range of outputs, beam angles, colour rendering and accessory options. The entire Dezzi range has been designed around a replaceable modular concept to support use in the circular economy.

Features



Certification



Dimensions

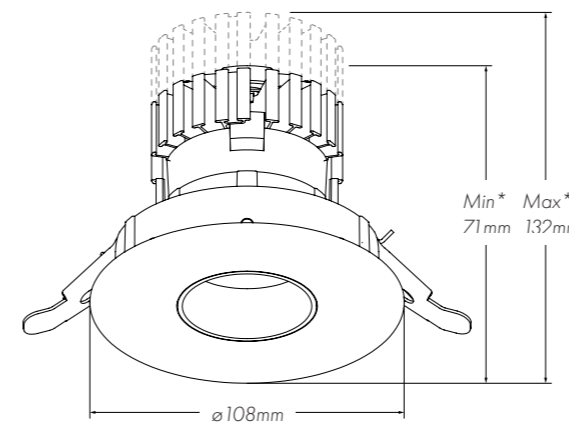

Product Builder

	Availability	XTM	XOB
Light Source	(XT)	<input type="checkbox"/>	<input type="checkbox"/>
	(XO)	<input type="checkbox"/>	<input type="checkbox"/>
Lumen Output	(05)	<input type="checkbox"/>	<input type="checkbox"/>
	(07)	<input type="checkbox"/>	<input type="checkbox"/>
	(10)	<input type="checkbox"/>	<input type="checkbox"/>
	(13)	<input type="checkbox"/>	<input type="checkbox"/>
	(20)	<input type="checkbox"/>	<input type="checkbox"/>
	(30)	<input type="checkbox"/>	<input type="checkbox"/>
Colour Temperature	(22)	<input type="checkbox"/>	<input type="checkbox"/>
	(27)	<input type="checkbox"/>	<input type="checkbox"/>
	(30)	<input type="checkbox"/>	<input type="checkbox"/>
	(35)	<input type="checkbox"/>	<input type="checkbox"/>
	(40)	<input type="checkbox"/>	<input type="checkbox"/>
	(56)	<input type="checkbox"/>	<input type="checkbox"/>
	(DW)	<input type="checkbox"/>	<input type="checkbox"/>
	(TW)	<input type="checkbox"/>	<input type="checkbox"/>
Colour Fidelity	(80)	<input type="checkbox"/>	<input type="checkbox"/>
	(90)	<input type="checkbox"/>	<input type="checkbox"/>
	(98)	<input type="checkbox"/>	<input type="checkbox"/>
	(V9)	<input type="checkbox"/>	<input type="checkbox"/>
	(BT)	<input type="checkbox"/>	<input type="checkbox"/>
Beam Angle	(SL)	<input type="checkbox"/>	<input type="checkbox"/>
	(2L)	<input type="checkbox"/>	<input type="checkbox"/>
	(NL)	<input type="checkbox"/>	<input type="checkbox"/>
	(ML)	<input type="checkbox"/>	<input type="checkbox"/>
	(NR)	<input type="checkbox"/>	<input type="checkbox"/>
	(MR)	<input type="checkbox"/>	<input type="checkbox"/>
	(DS)	<input type="checkbox"/>	<input type="checkbox"/>
	(D2)	<input type="checkbox"/>	<input type="checkbox"/>
	(DN)	<input type="checkbox"/>	<input type="checkbox"/>
	(DM)	<input type="checkbox"/>	<input type="checkbox"/>
Trim Colour	(W)	<input type="checkbox"/>	<input type="checkbox"/>
	(B)	<input type="checkbox"/>	<input type="checkbox"/>
	(P)	<input type="checkbox"/>	<input type="checkbox"/>
Bezel Colour	(BI)	<input type="checkbox"/>	<input type="checkbox"/>
Control	/DD	<input type="checkbox"/>	<input type="checkbox"/>
	/DP	<input type="checkbox"/>	<input type="checkbox"/>
	/DA	<input type="checkbox"/>	<input type="checkbox"/>
	/AP	<input type="checkbox"/>	<input type="checkbox"/>
	/PH	<input type="checkbox"/>	<input type="checkbox"/>
	/BC	<input type="checkbox"/>	<input type="checkbox"/>
	/DX	<input type="checkbox"/>	<input type="checkbox"/>
	/ND	<input type="checkbox"/>	<input type="checkbox"/>
Emergency	/M3	<input type="checkbox"/>	<input type="checkbox"/>
	/ST	<input type="checkbox"/>	<input type="checkbox"/>
	/DE	<input type="checkbox"/>	<input type="checkbox"/>
Accessories	/HL	<input type="checkbox"/>	<input type="checkbox"/>
	/CG	<input type="checkbox"/>	<input type="checkbox"/>
	/SL	<input type="checkbox"/>	<input type="checkbox"/>
	/RG	<input type="checkbox"/>	<input type="checkbox"/>
	/CF	<input type="checkbox"/>	<input type="checkbox"/>
Key	Available	<input type="checkbox"/>	<input type="checkbox"/>
	Not Available	<input type="checkbox"/>	<input type="checkbox"/>

*based on output and beam angle, see spec sheets.

Light Source



Output

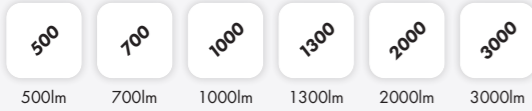

Colour Temperature

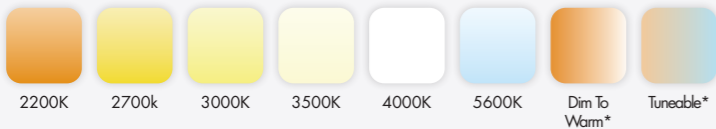

Colour Fidelity

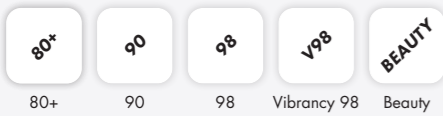

Beam Angle



Trim Colour

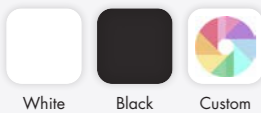

Bezel Colour

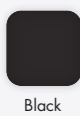

Accessories

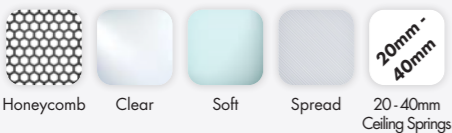

*available on request.



dezzi

DEZZI PIN HOLE SQUARE

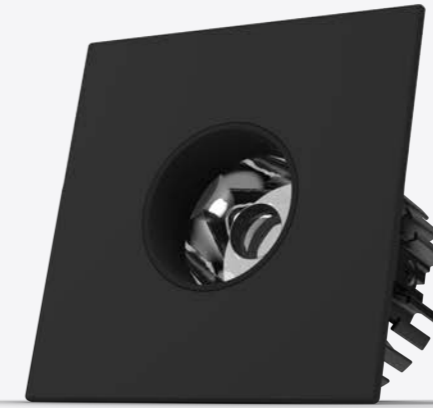

Description

The Dezzi Pin Hole Square is a high performance LED downlight, available with a large range of outputs, beam angles, colour rendering and accessory options. The entire Dezzi range has been designed around a replaceable modular concept to support use in the circular economy.

Features



Certification



Dimensions

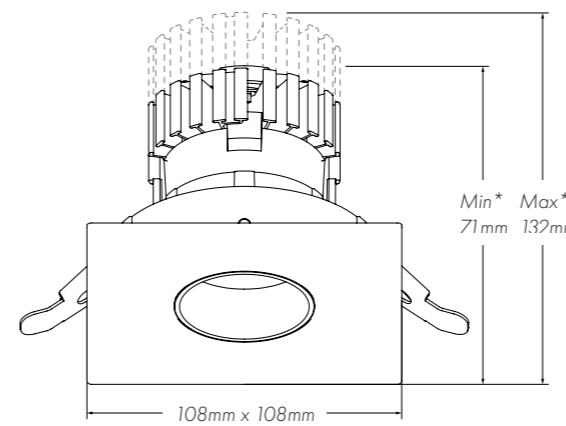

Product Builder

	Availability	XTM	XOB
Light Source	(XT)	<input type="radio"/>	<input type="radio"/>
	(XO)	<input type="radio"/>	<input type="radio"/>
Lumen Output	(05)	<input type="radio"/>	<input type="radio"/>
	(07)	<input type="radio"/>	<input type="radio"/>
	(10)	<input type="radio"/>	<input type="radio"/>
	(13)	<input type="radio"/>	<input type="radio"/>
	(20)	<input type="radio"/>	<input type="radio"/>
	(30)	<input type="radio"/>	<input type="radio"/>
Colour Temperature	(22)	<input type="radio"/>	<input type="radio"/>
	(27)	<input type="radio"/>	<input type="radio"/>
	(30)	<input type="radio"/>	<input type="radio"/>
	(35)	<input type="radio"/>	<input type="radio"/>
	(40)	<input type="radio"/>	<input type="radio"/>
	(56)	<input type="radio"/>	<input type="radio"/>
	(DW)	<input type="radio"/>	<input type="radio"/>
	(TW)	<input type="radio"/>	<input type="radio"/>
Colour Fidelity	(80)	<input type="radio"/>	<input type="radio"/>
	(90)	<input type="radio"/>	<input type="radio"/>
	(98)	<input type="radio"/>	<input type="radio"/>
	(V9)	<input type="radio"/>	<input type="radio"/>
	(BT)	<input type="radio"/>	<input type="radio"/>
Beam Angle	(SL)	<input type="radio"/>	<input type="radio"/>
	(2L)	<input type="radio"/>	<input type="radio"/>
	(NL)	<input type="radio"/>	<input type="radio"/>
	(ML)	<input type="radio"/>	<input type="radio"/>
	(NR)	<input type="radio"/>	<input type="radio"/>
	(MR)	<input type="radio"/>	<input type="radio"/>
	(DS)	<input type="radio"/>	<input type="radio"/>
	(D2)	<input type="radio"/>	<input type="radio"/>
	(DN)	<input type="radio"/>	<input type="radio"/>
	(DM)	<input type="radio"/>	<input type="radio"/>
Trim Colour	(W)	<input type="radio"/>	<input type="radio"/>
	(B)	<input type="radio"/>	<input type="radio"/>
	(P)	<input type="radio"/>	<input type="radio"/>
Bezel Colour	(BI)	<input type="radio"/>	<input type="radio"/>
DPS	/**/**		
Control	/DD	<input type="radio"/>	<input type="radio"/>
	/DP	<input type="radio"/>	<input type="radio"/>
	/DA	<input type="radio"/>	<input type="radio"/>
	/AP	<input type="radio"/>	<input type="radio"/>
	/PH	<input type="radio"/>	<input type="radio"/>
	/BC	<input type="radio"/>	<input type="radio"/>
	/DX	<input type="radio"/>	<input type="radio"/>
	/ND	<input type="radio"/>	<input type="radio"/>
Emergency	/M3	<input type="radio"/>	<input type="radio"/>
	/ST	<input type="radio"/>	<input type="radio"/>
	/DE	<input type="radio"/>	<input type="radio"/>
Accessories	/HL	<input type="radio"/>	<input type="radio"/>
	/CG	<input type="radio"/>	<input type="radio"/>
	/SL	<input type="radio"/>	<input type="radio"/>
	/RG	<input type="radio"/>	<input type="radio"/>
	/CF	<input type="radio"/>	<input type="radio"/>
Key	Available	<input type="radio"/>	<input type="radio"/>
	Not Available	<input type="radio"/>	<input type="radio"/>

*based on output and beam angle, see spec sheets.

'Here at alphaLED we believe in a culture of responsibility both towards our clients and towards the global environment. We pride ourselves on delivering great products without compromising our promises on sustainability. We have always designed products to last long beyond the industry norms and are now backing this philosophy up with our exciting new renew program.'

DESIGNED FOR THE CIRCULAR ECONOMY



We're now introducing our new renew program. Once our fixtures have reached their End-of-Life these can be renewed with a brand new light engine and/or control gear.

- End-of-life renew service.
- 20-year duty of care for parts and repair of fixtures.
- Look out for our 'Renew Logo' on each fixture with our contact details.

alphaLED

alphaLED are constantly developing and improving our product range. All descriptions, illustrations, drawings and specifications in this catalogue are present and correct, they perform only general particulars and shall not form any part of any contract. The right is reserved to change specifications without prior notification or public announcement. All goods supplied by the company are supplied subject to the company's General Conditions of sale, a copy of which is available on request.

Projection
lighting

4th Avenue, The Village
Trafford Park, Manchester
England, M17 1DB

0161 873 7841
sales@alphaled.co.uk

www.alphaled.co.uk



alpha**LED**

